









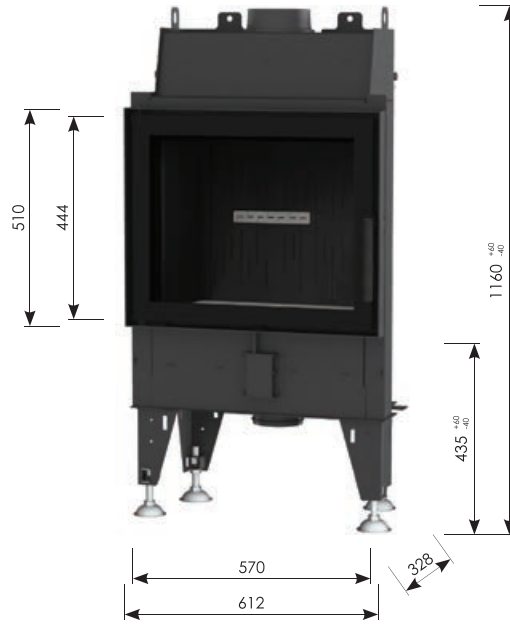

BEF HOME
fire for your heart

BEF FLAT 6

	3 - 6 kW
	84 %
	ø 150 mm
	40 cm
	116 kg



BEF FLAT 7

	4 - 7 kW
	82 %
	ø 150 mm
	40 cm
	124 kg

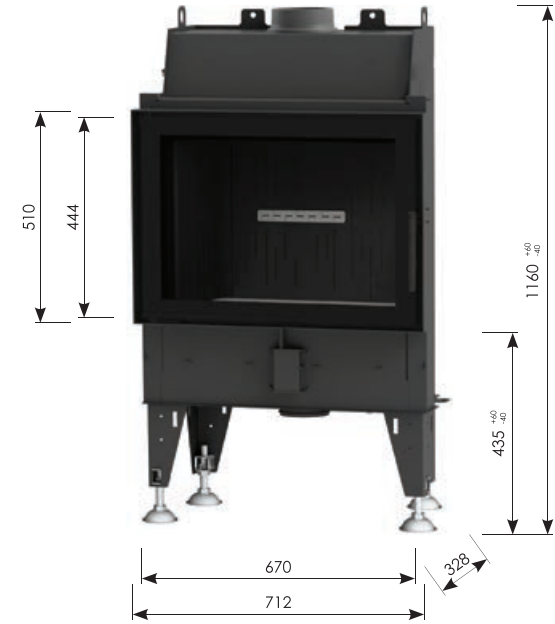

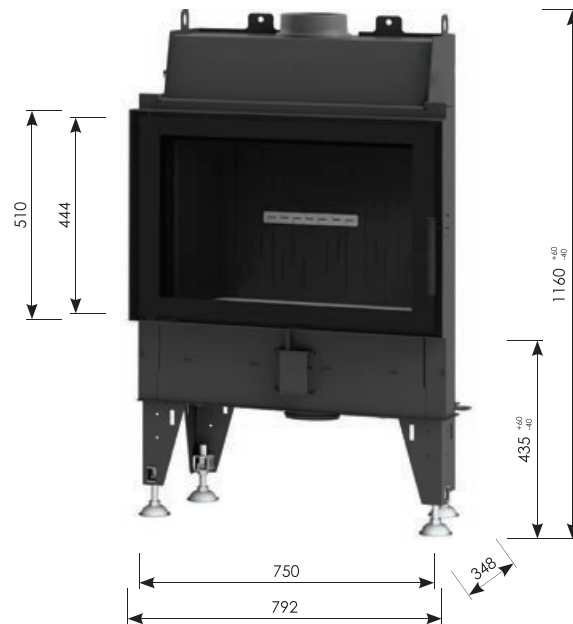

BEF FLAT 8

	5 - 8 kW
	85 %
	ø 180 mm
	50 cm
	137 kg



BEF FLAT V 6

	3 - 6 kW
	84 %
	ø 150 mm
	40 cm
	159 kg

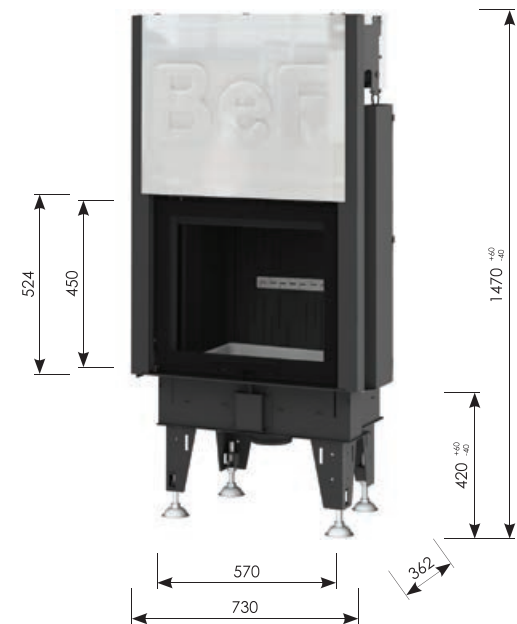

BEF FLAT V 7

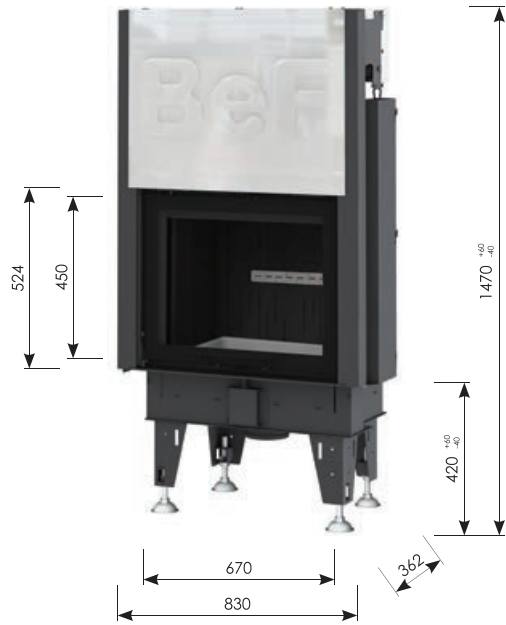

	4 - 7 kW
	82 %
	ø 150 mm
	40 cm
	179 kg

BEF FLAT V 8

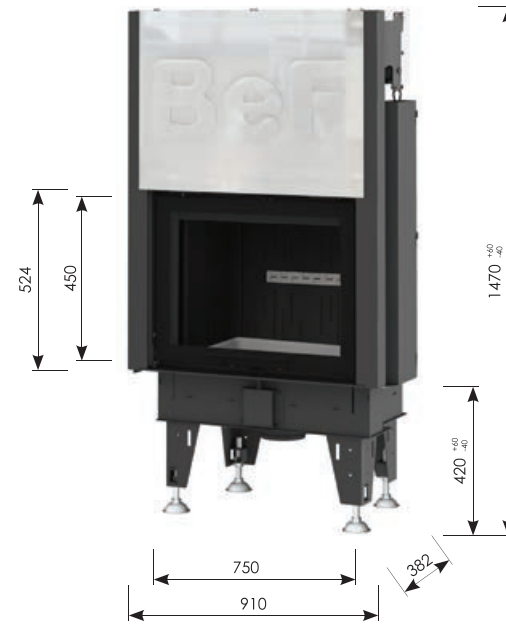

	5 - 8 kW
	85 %
	ø 180 mm
	50 cm
	198 kg

BEF FLAT 6 CP/CL

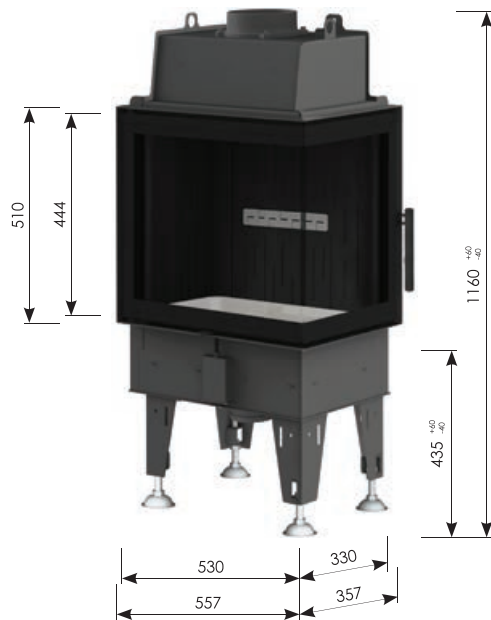

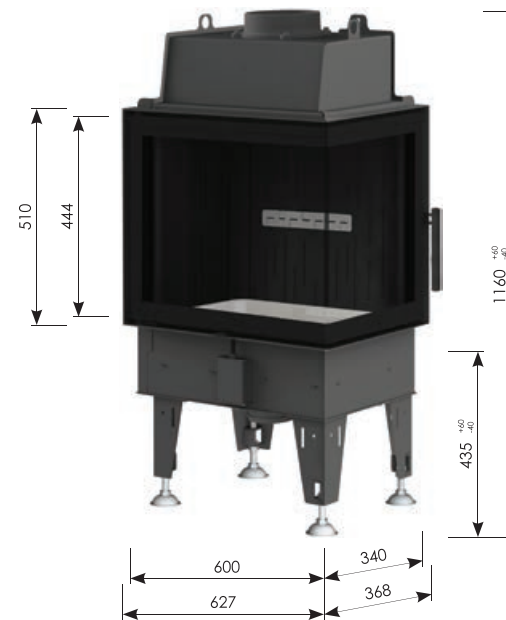

	3 - 6 kW
	84 %
	ø 150 mm
	33 cm
	104 kg

BEF FLAT 7 CP/CL





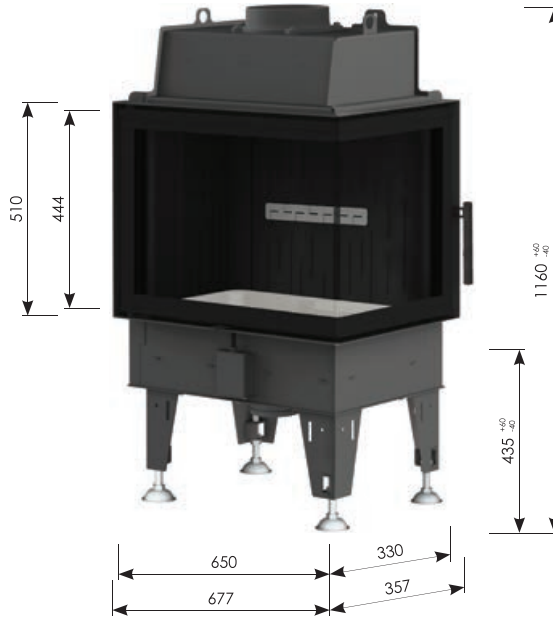

	4 - 7 kW
	82 %
	ø 150 mm
	40 cm
	115 kg

BEF FLAT 8 CP/CL

	5 - 8 kW
	85 %
	Ø 180 mm
	40 cm
	121 kg





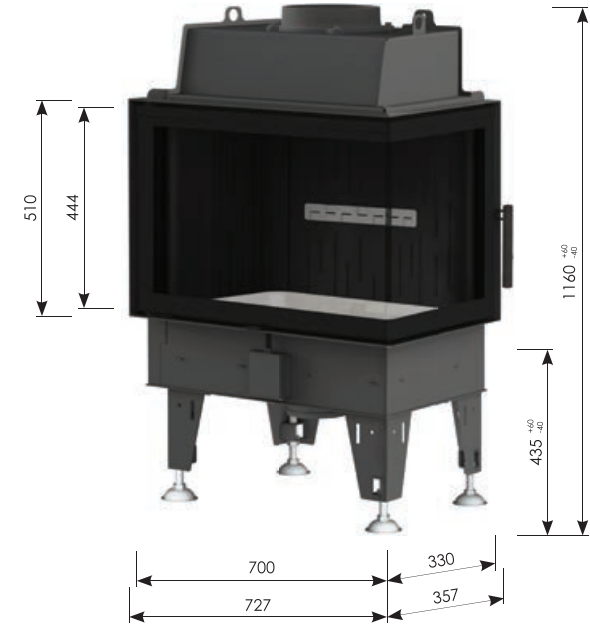

BEF FLAT 9 CP/CL

	5 - 8 kW
	85 %
	Ø 180 mm
	50 cm
	123 kg





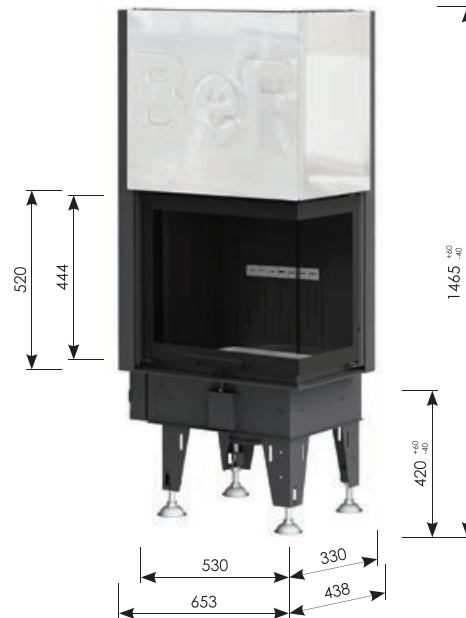

BEF FLAT V 6 CP/CL

	3 - 6 kW
	84 %
	Ø 150 mm
	33 cm
	104 kg



BEF FLAT V 7 CP/CL

	4 - 7 kW
	82 %
	Ø 150 mm
	40 cm
	178 kg



BEF FLAT V 8 CP/CL

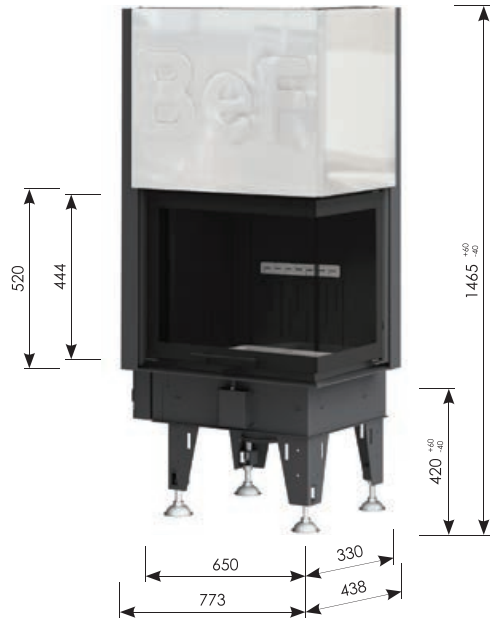

	5 - 8 kW
	85 %
	ø 180 mm
	40 cm
	186 kg

BEF FLAT V 9 CP/CL



	5 - 8 kW
	85 %
	ø 180 mm
	50 cm
	188 kg

BEF FLAT 4 L

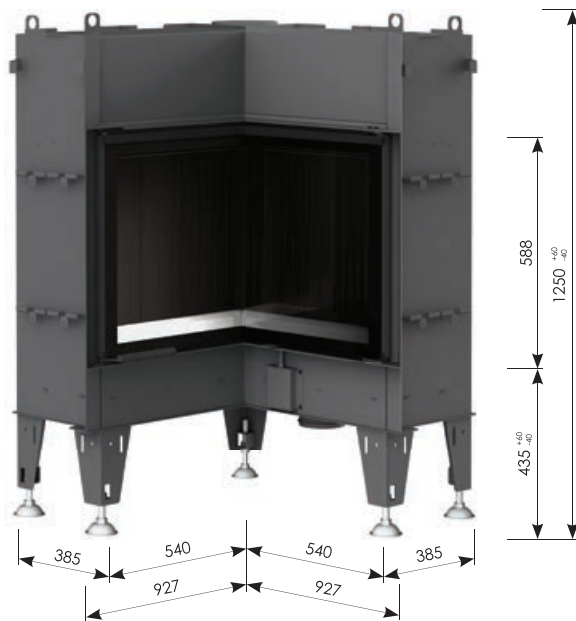



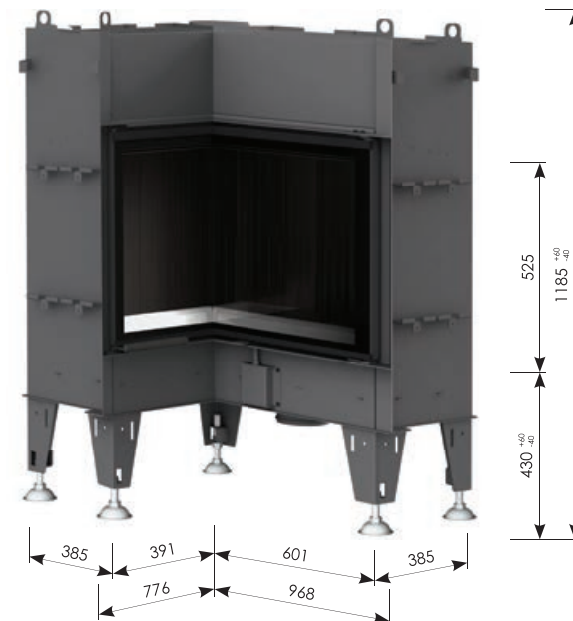

	5 - 8 kW
	82 %
	ø 180 mm
	50 cm
	264 kg

BEF FLAT 6 L





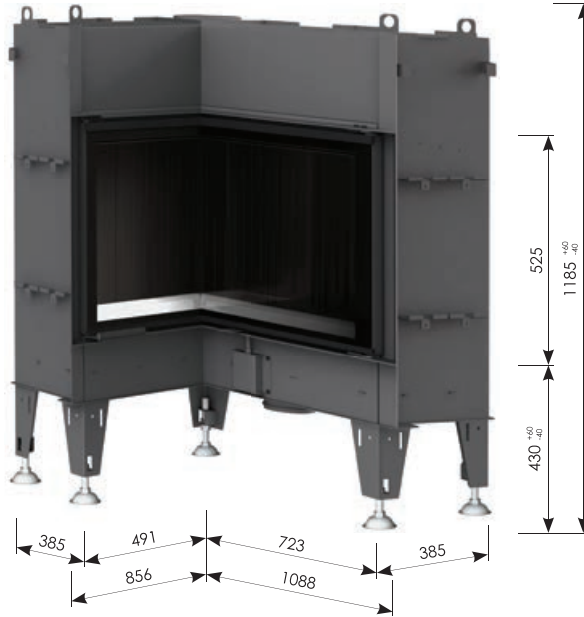

	3 - 6 kW
	84 %
	ø 180 mm
	40 cm
	233 kg

BEF FLAT 8 L

	5 - 8 kW
	85 %
	ø 180 mm
	50 cm
	249 kg





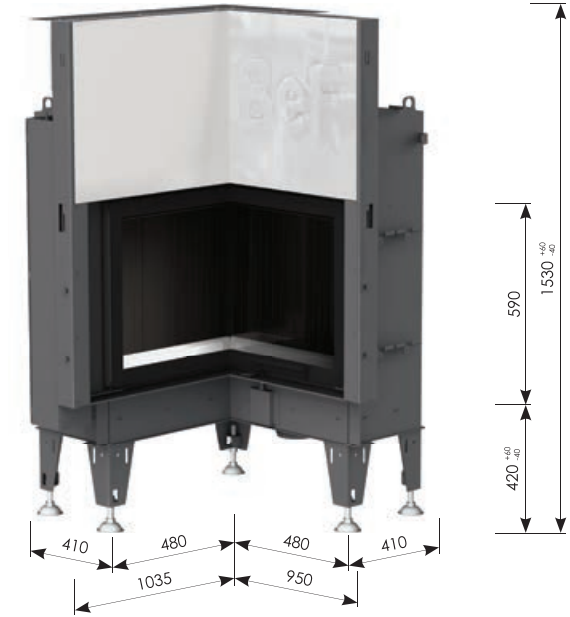

BEF FLAT V 4 L

	5 - 8 kW
	82 %
	ø 180 mm
	50 cm
	353 kg





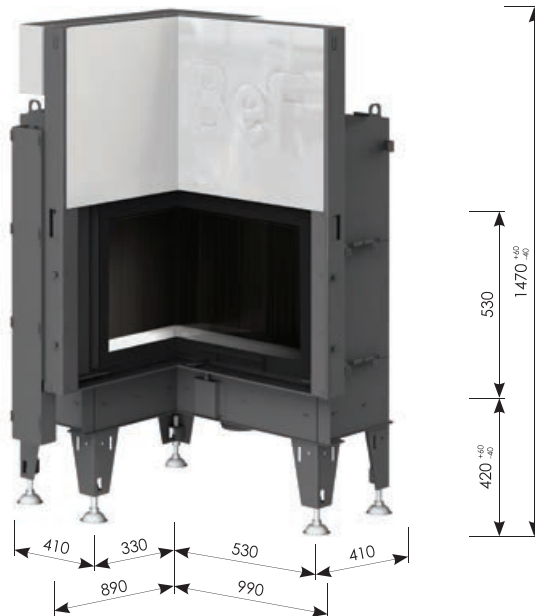

BEF FLAT V 6 L

	3 - 6 kW
	84 %
	ø 180 mm
	40 cm
	308 kg





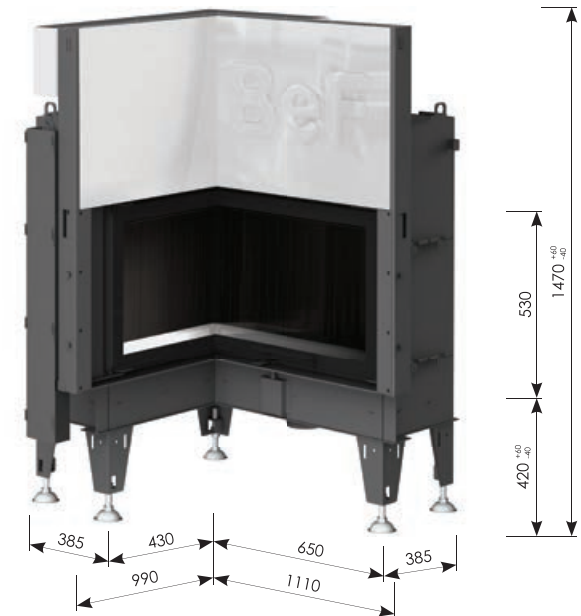

BEF FLAT V 8 L

	5 - 8 kW
	85 %
	ø 180 mm
	50 cm
	350 kg





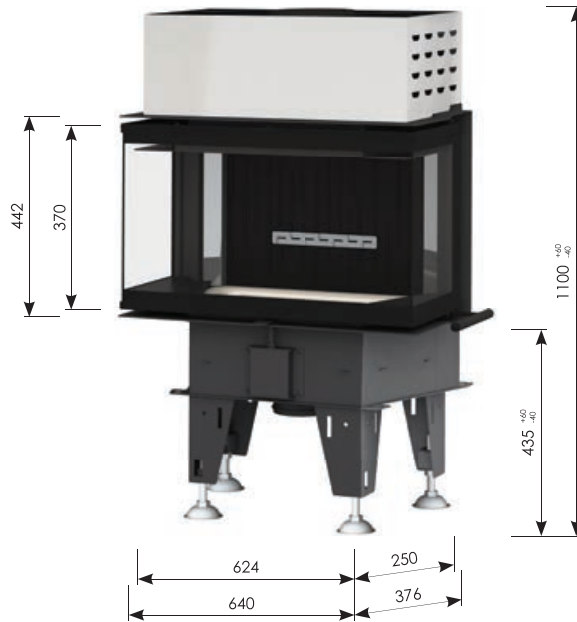

BEF FLAT 6 C

	3 - 6 kW
	84 %
	ø 180 mm
	33 cm
	105 kg





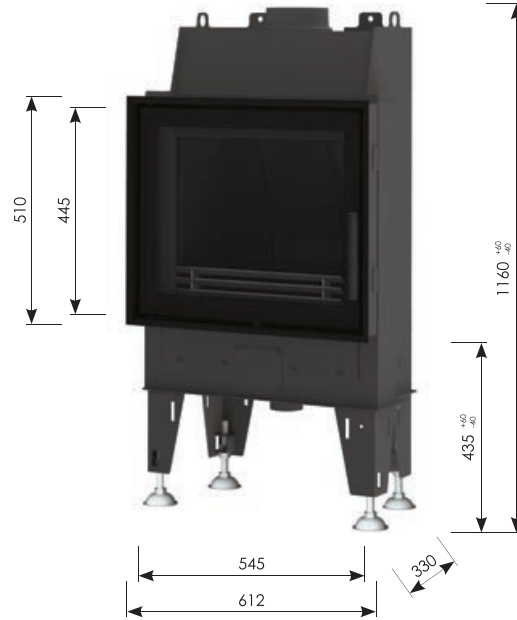

BEF PASSIVE 6

	3 - 6 kW
	86 %
	ø 150 mm
	33 cm
	116 kg





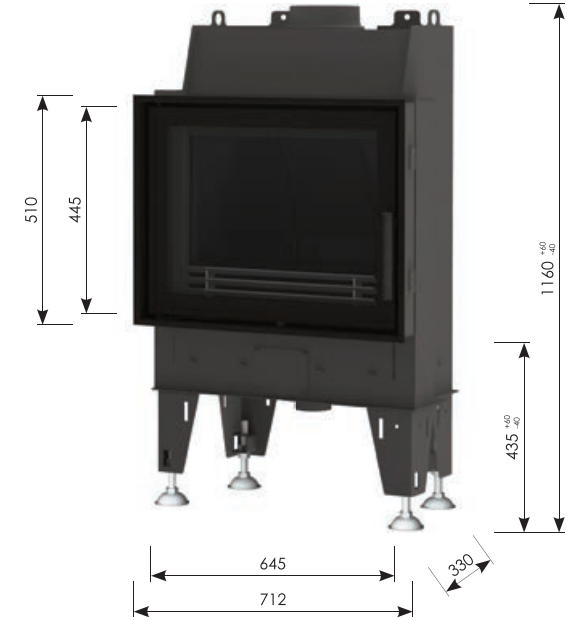

BEF PASSIVE 7

	4 - 7 kW
	84 %
	ø 150 mm
	40 cm
	132 kg





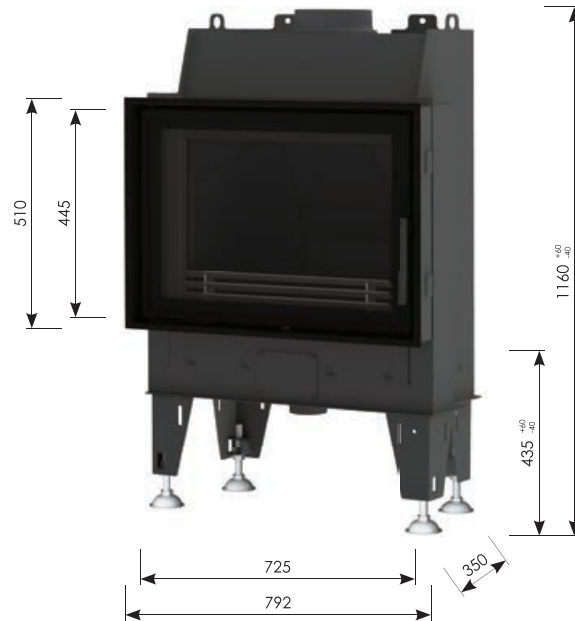

BEF PASSIVE 8

	5 - 8 kW
	84 %
	ø 180 mm
	50 cm
	146 kg



BEF PASSIVE 6 CP/CL

	3 - 6 kW
	86 %
	ø 150 mm
	33 cm
	112 kg

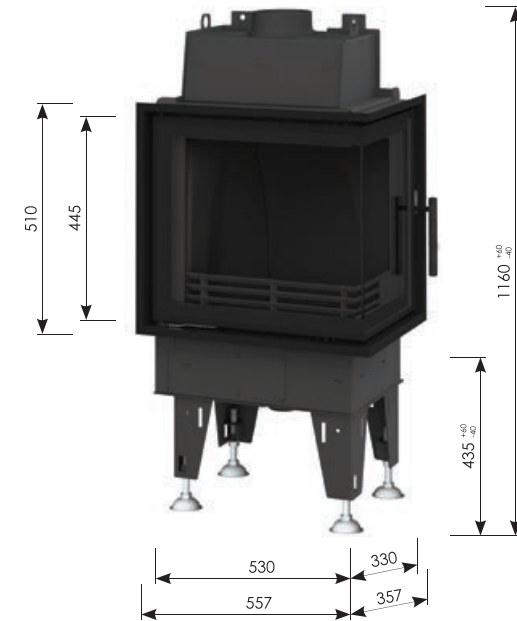



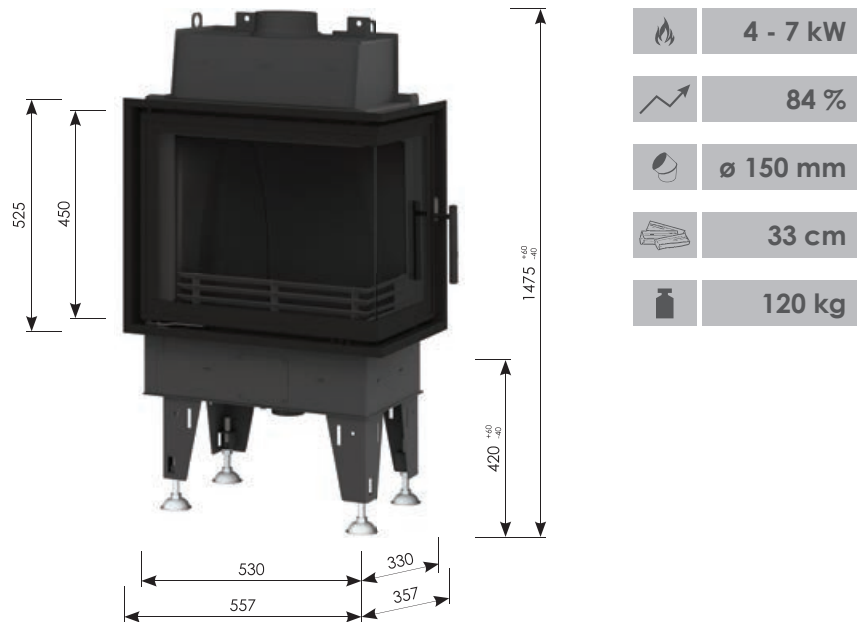

BEF PASSIVE 7 CP/CL

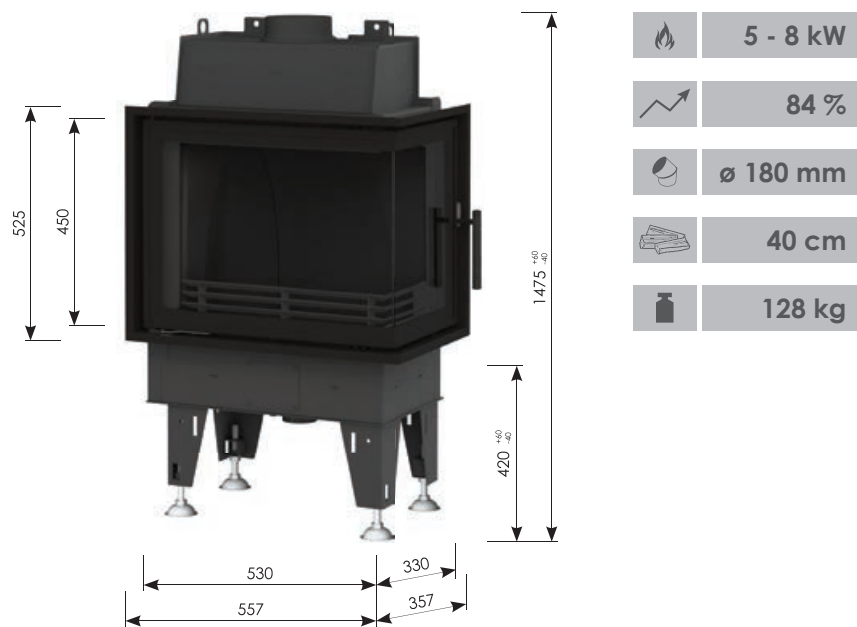

BEF PASSIVE 8 CP/CL





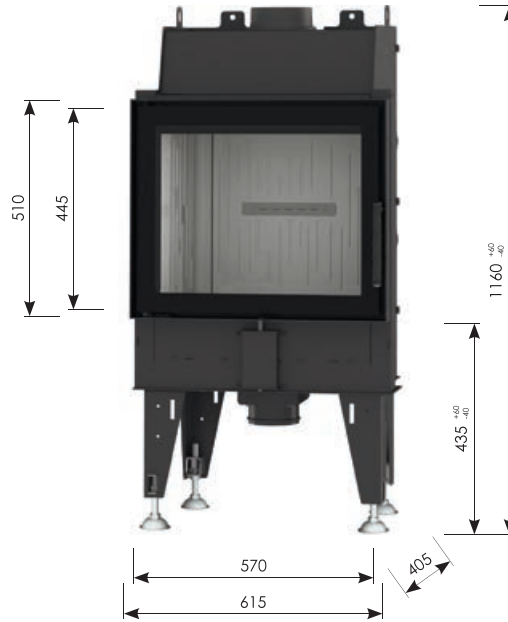

BEF TREND 6

	4 - 7 kW
	82 %
	ø 150 mm
	33 cm
	130 kg



BEF TREND 8

	7 - 10 kW
	84 %
	ø 200 mm
	50 cm
	152 kg

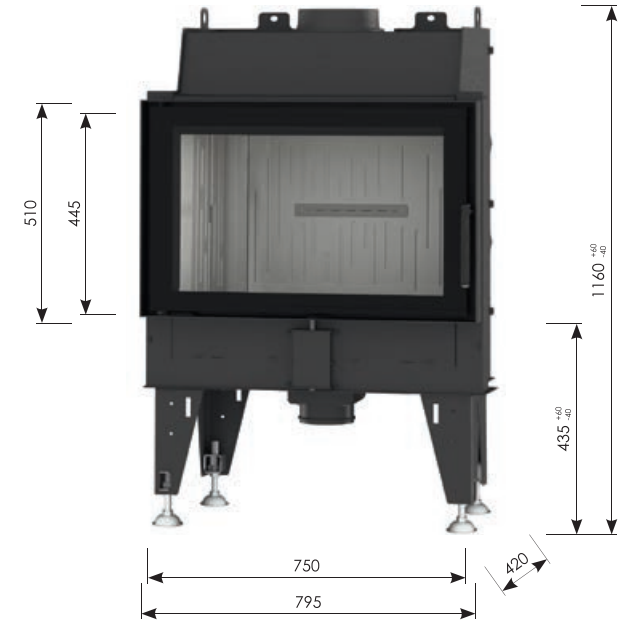



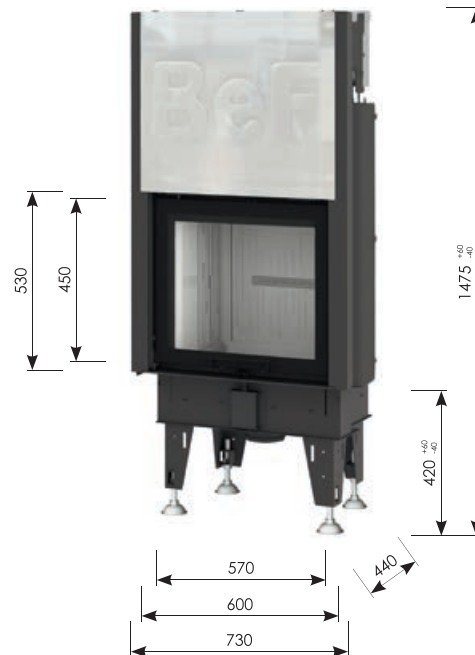

BEF TREND V 6

	4 - 7 kW
	82 %
	ø 150 mm
	33 cm
	182 kg



BEF TREND V 8

	7 - 10 kW
	84 %
	ø 200 mm
	50 cm
	215 kg

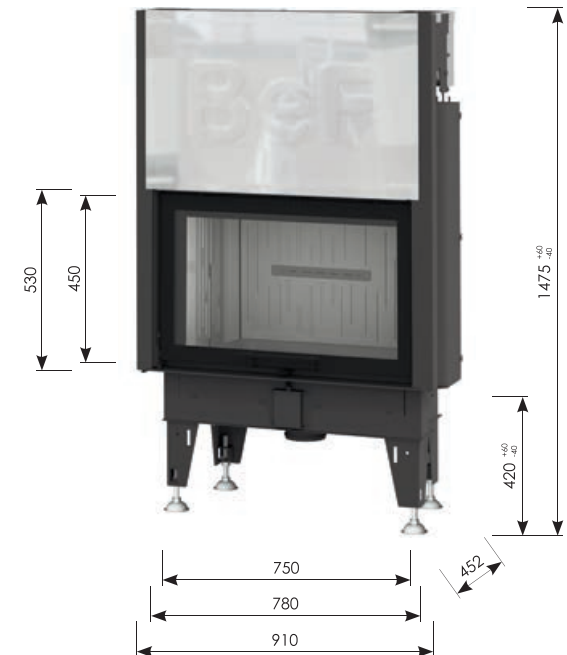

BEF TREND V 10

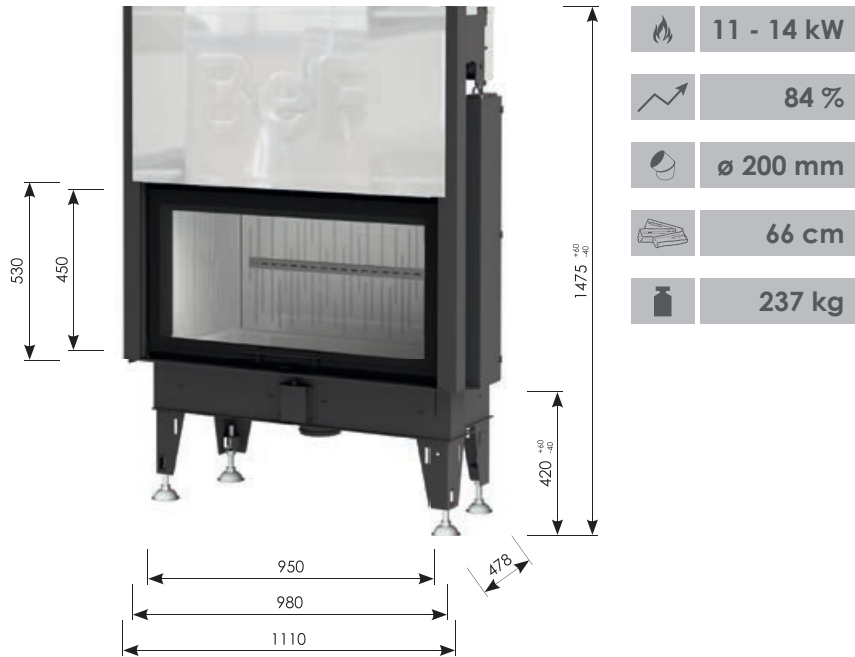

BEF TREND V 12

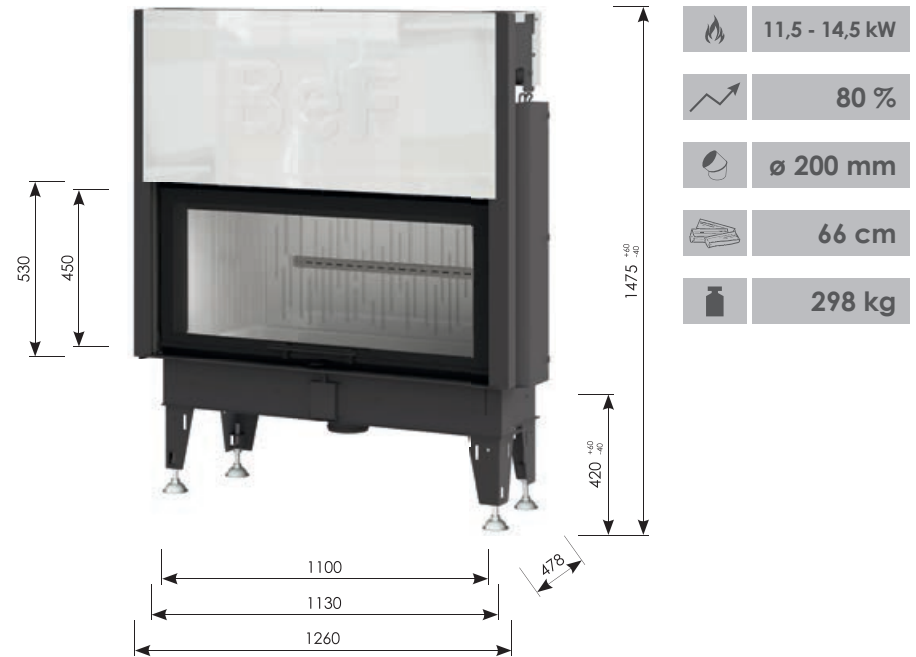



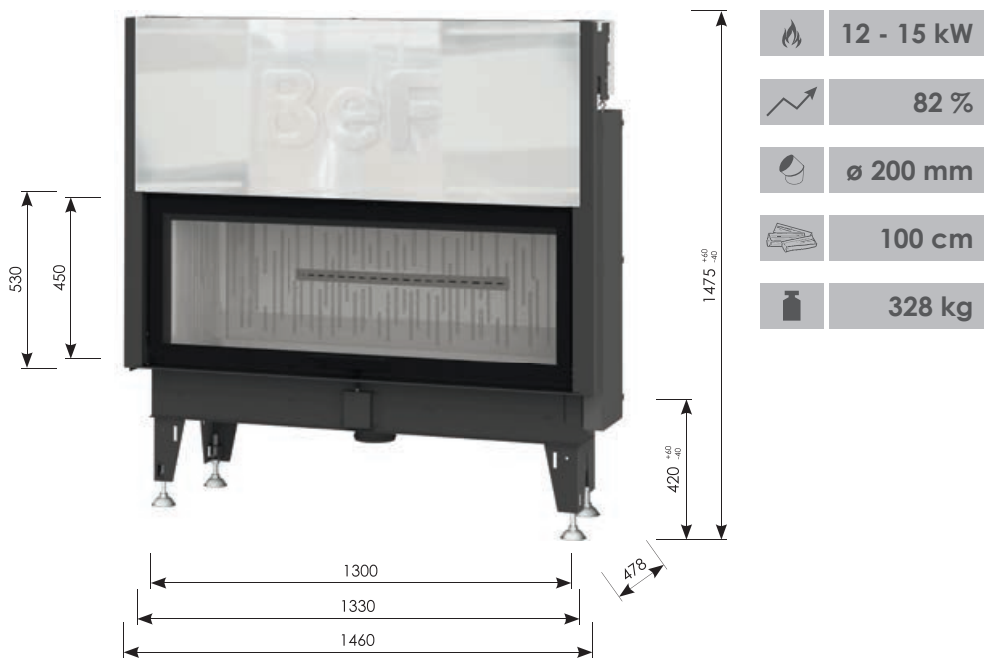

BEF TREND V 14

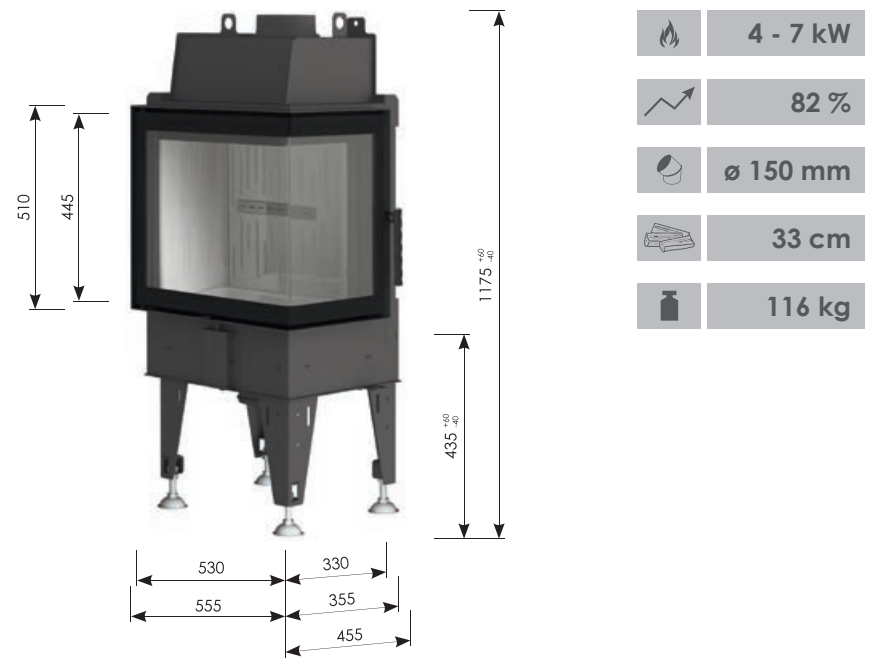

BEF TREND 6 CP/CL





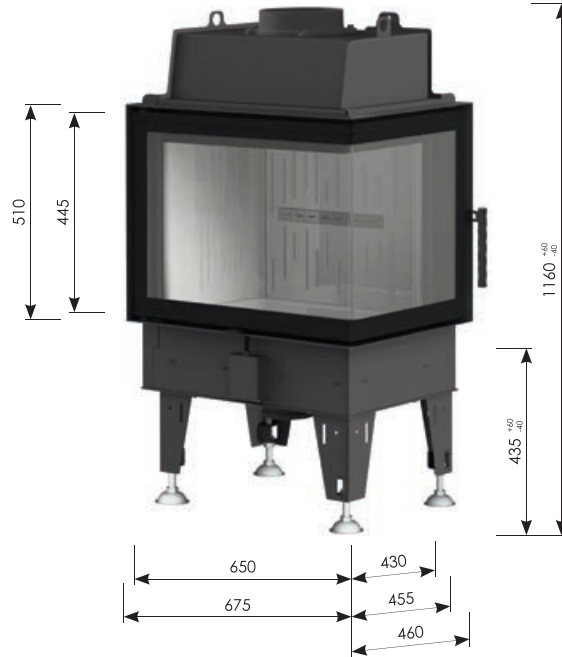

BEF TREND 8 CP/CL

	7 - 10 kW
	84 %
	ø 200 mm
	40 cm
	134 kg





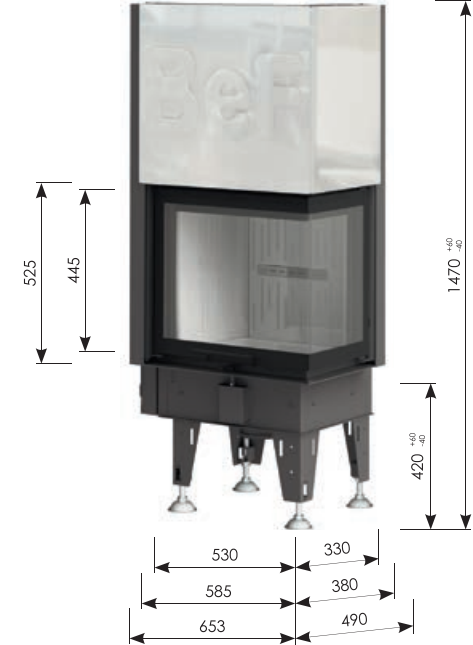

BEF TREND V 6 CP/CL

	4 - 7 kW
	82 %
	ø 150 mm
	33 cm
	175 kg





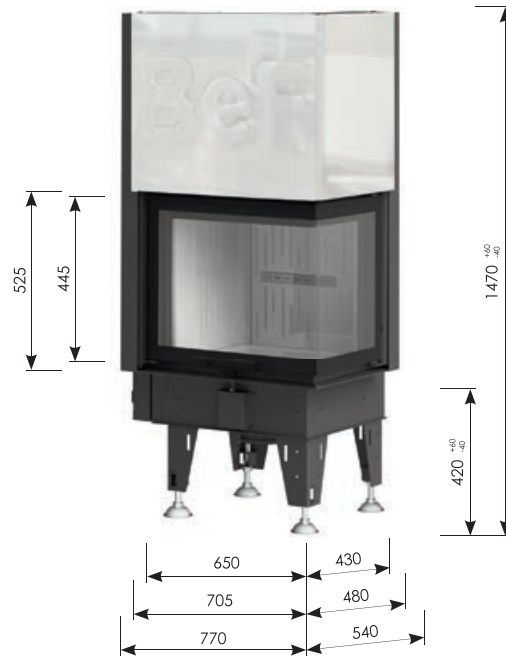

BEF TREND V 8 CP/CL

	7 - 10 kW
	84 %
	ø 200 mm
	40 cm
	197 kg



BEF TREND V 10 CP/CL

	11 - 14 kW
	84 %
	ø 200 mm
	66 cm
	244 kg

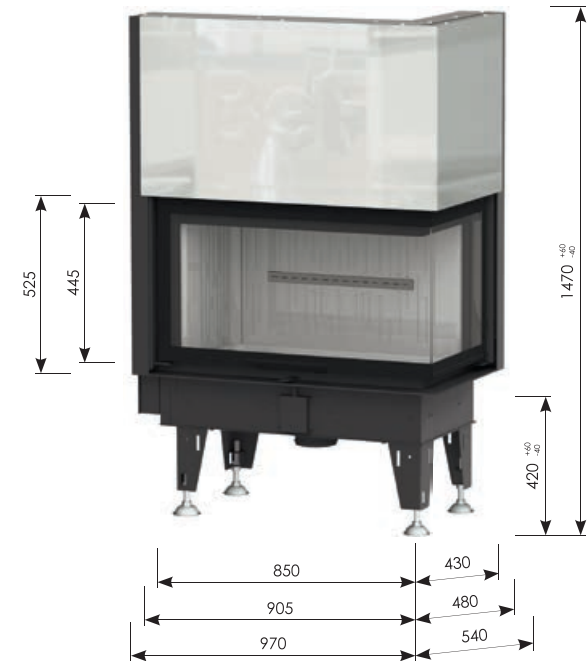

BEF TREND V 6 C

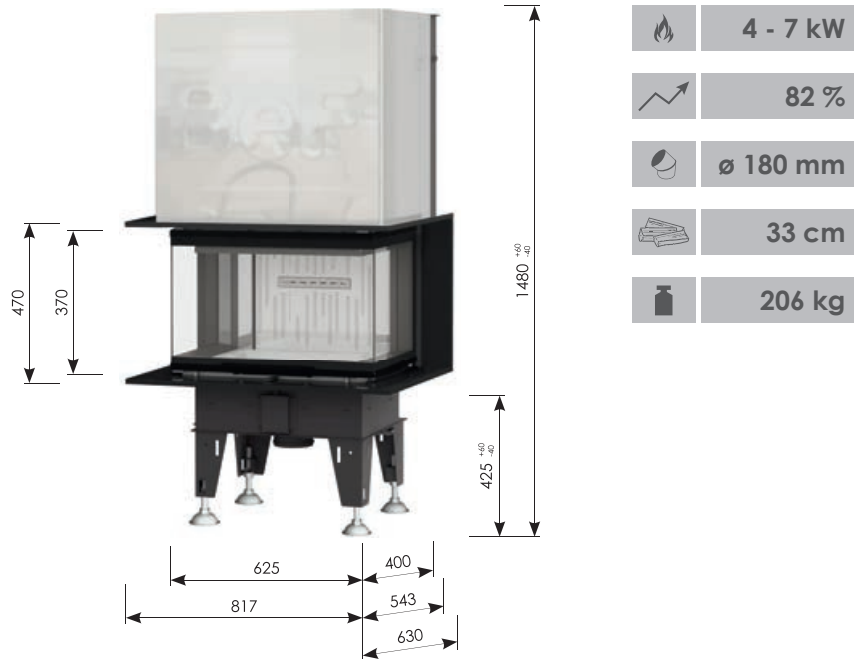

BEF TREND V 8 C

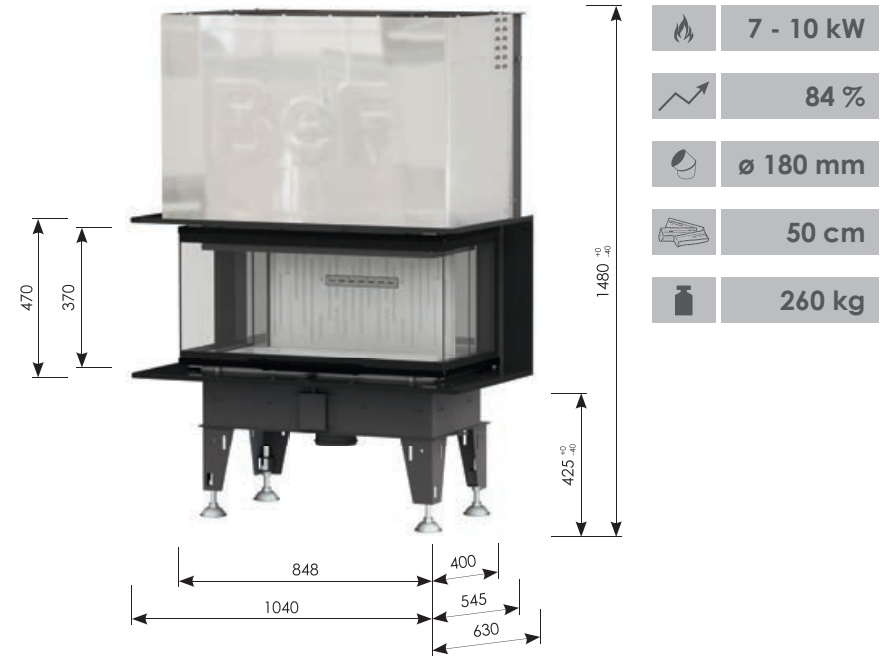



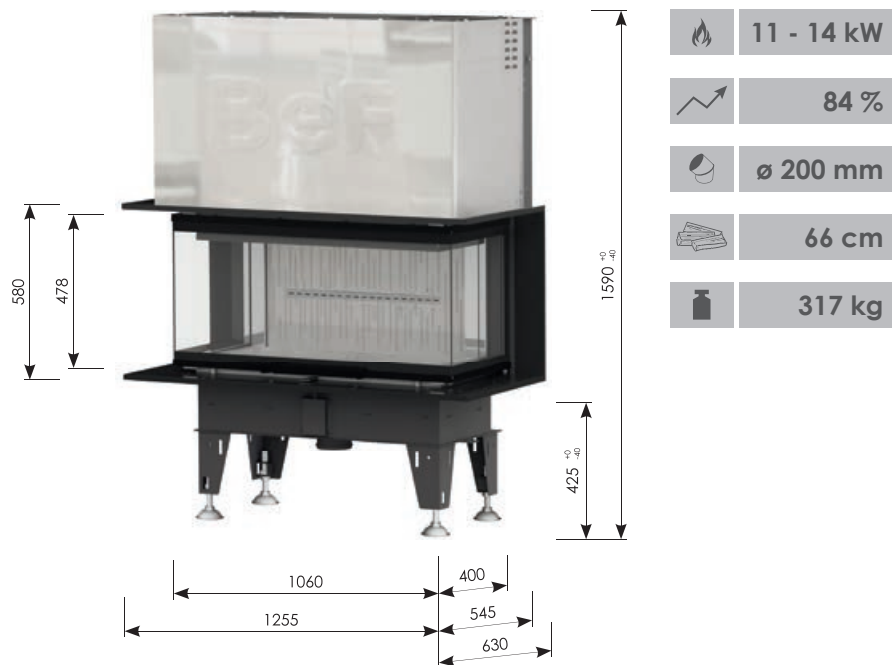

BEF TREND V 10 C

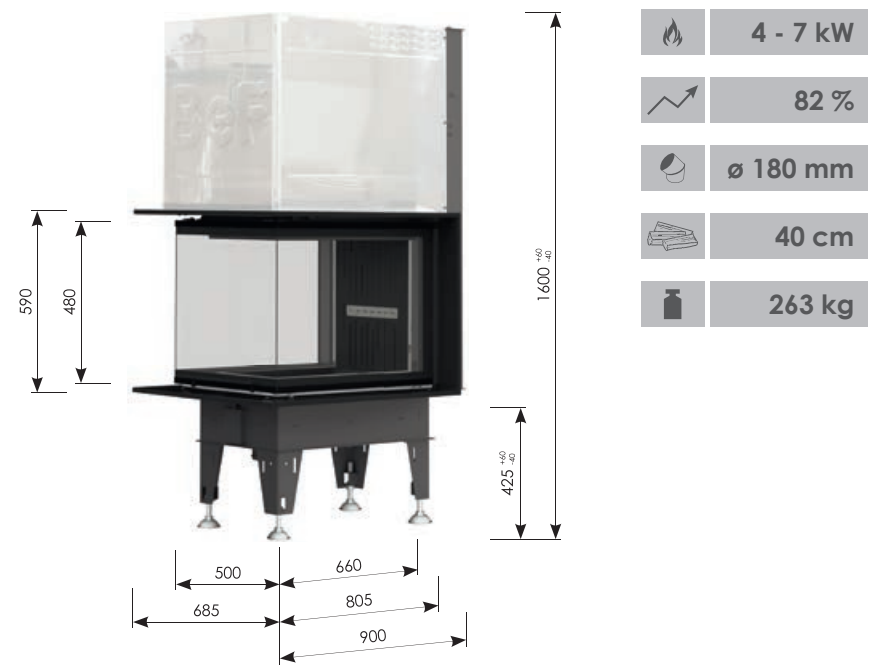

BEF TREND V 6 U







BEF TREND V 8 U

	7 - 10 kW
	84 %
	ø 200 mm
	50 cm
	365 kg







BEF TREND V 10 U

	11 - 14 kW
	84 %
	ø 200 mm
	66 cm
	418 kg







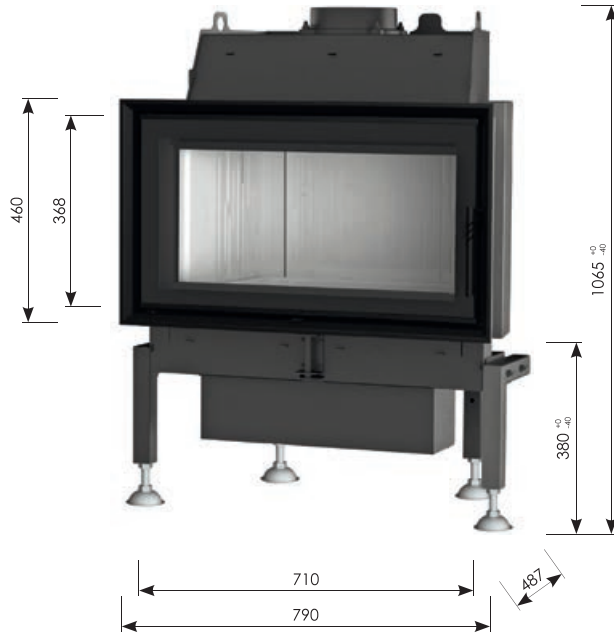

TREND 7

	6 - 11 kW
	80 %
	ø 180 mm
	40 cm
	116 kg





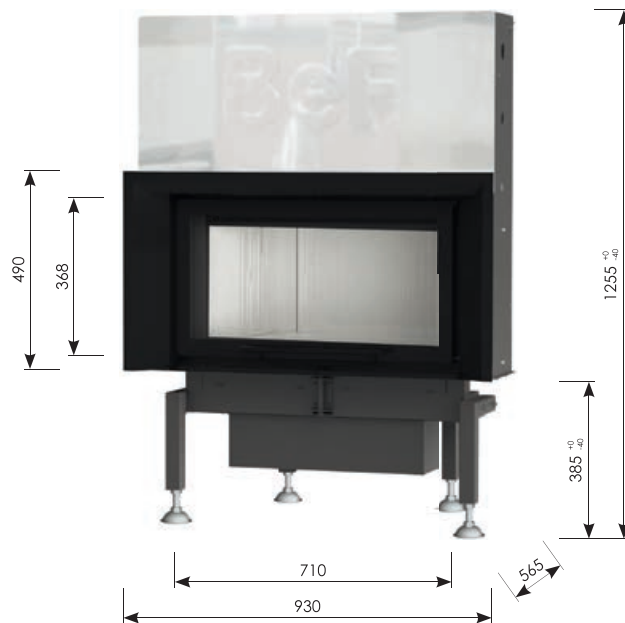

TREND V 7

	6 - 11 kW
	80 %
	ø 180 mm
	40 cm
	168 kg







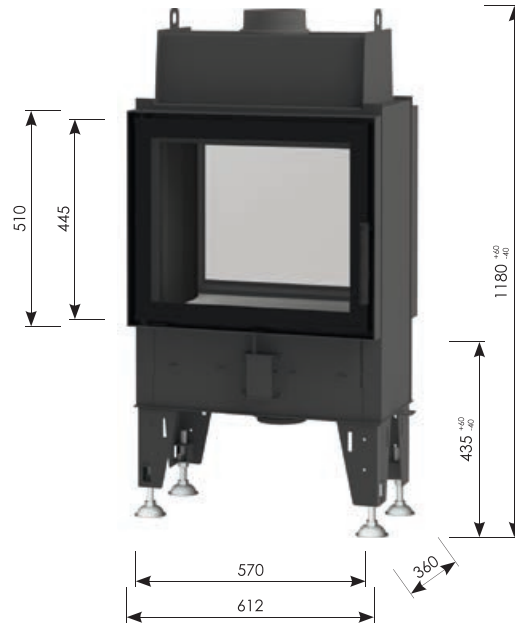

BEF FLAT 6 TWIN

	3 - 6 kW
	84 %
	ø 150 mm
	33 cm
	109 kg





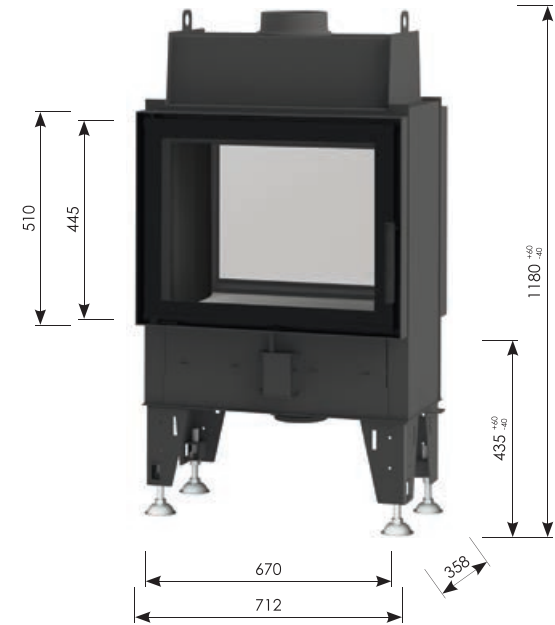

BEF FLAT 7 TWIN

	4 - 7 kW
	82 %
	ø 150 mm
	40 cm
	119 kg





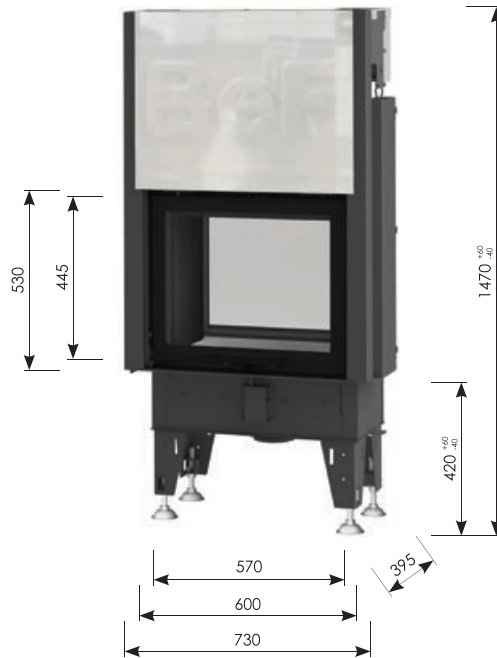

BEF FLAT V 6 TWIN

	3 - 6 kW
	84 %
	ø 150 mm
	33 cm
	157 kg



BEF FLAT V 7 TWIN

	4 - 7 kW
	82 %
	ø 150 mm
	40 cm
	177 kg

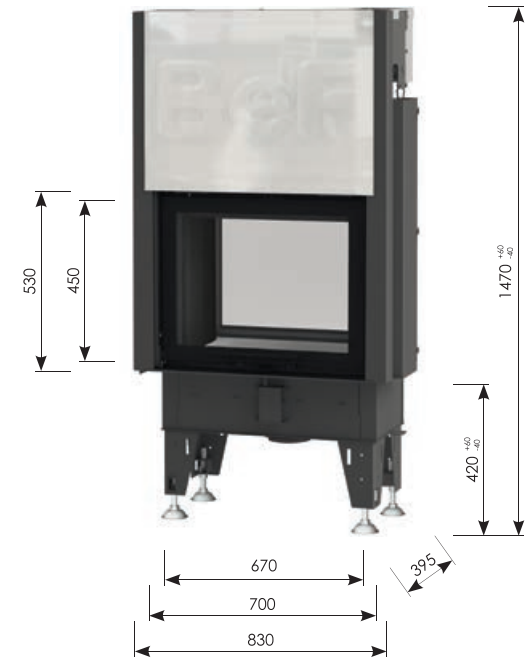

BEF FLAT 6 N TWIN

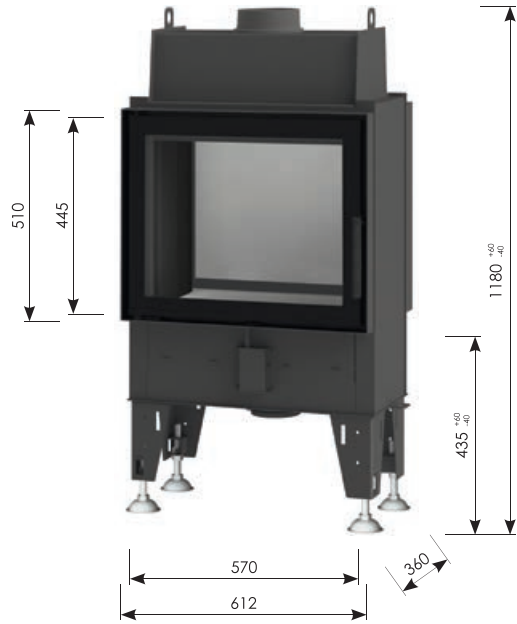

	3 - 6 kW
	84 %
	ø 150 mm
	33 cm
	113 kg



BEF FLAT 7 N TWIN

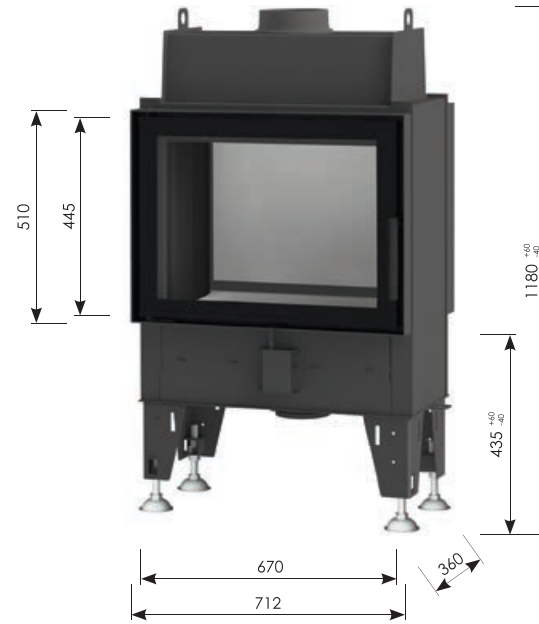

	4 - 7 kW
	82 %
	ø 150 mm
	40 cm
	124 kg



BEF FLAT V 6 N TWIN

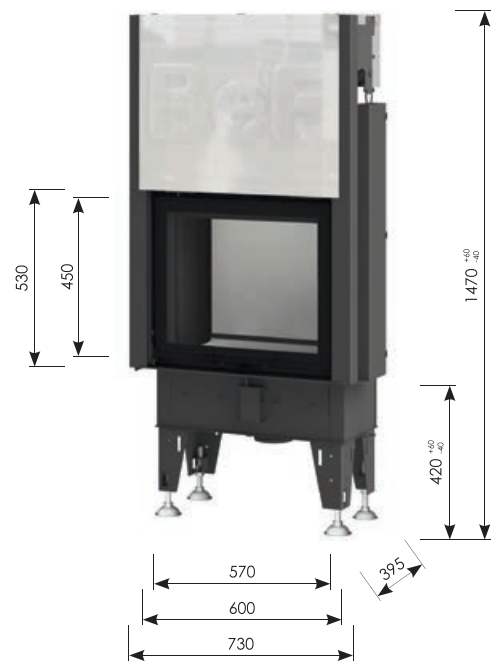

	3 - 6 kW
	84 %
	ø 150 mm
	33 cm
	164 kg





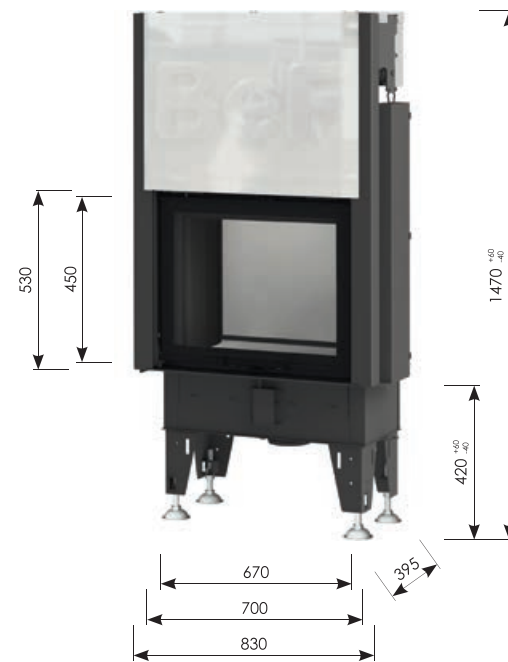

BEF FLAT V 7 N TWIN



	4 - 7 kW
	82 %
	ø 150 mm
	40 cm
	180 kg





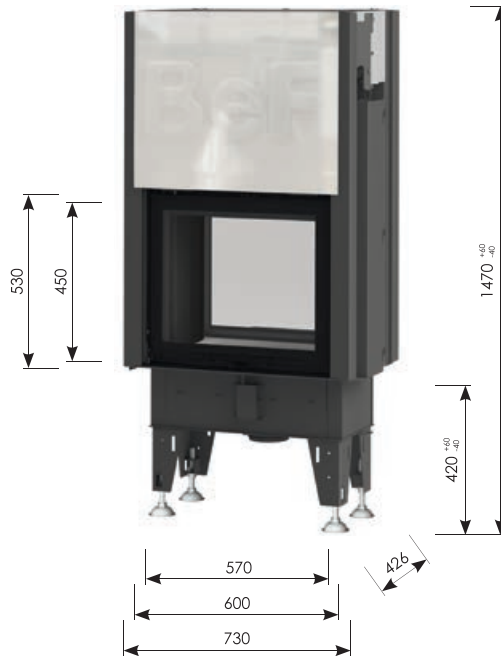

BEF FLAT V V 6 TWIN

	3 - 6 kW
	84 %
	ø 150 mm
	33 cm
	209 kg





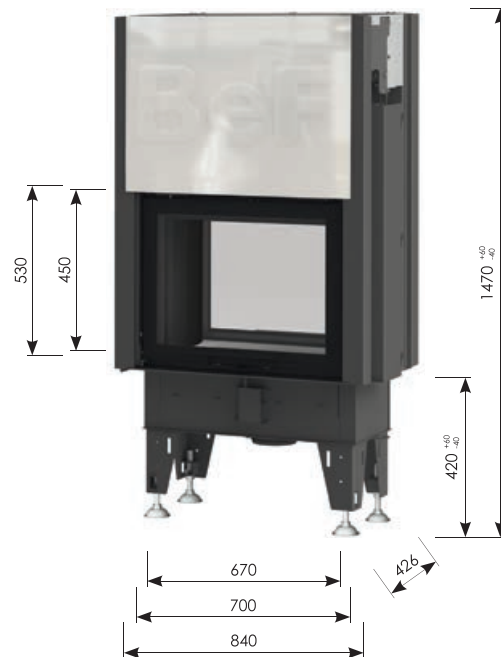

BEF FLAT V V 7 TWIN

	4 - 7 kW
	82 %
	ø 150 mm
	40 cm
	231 kg







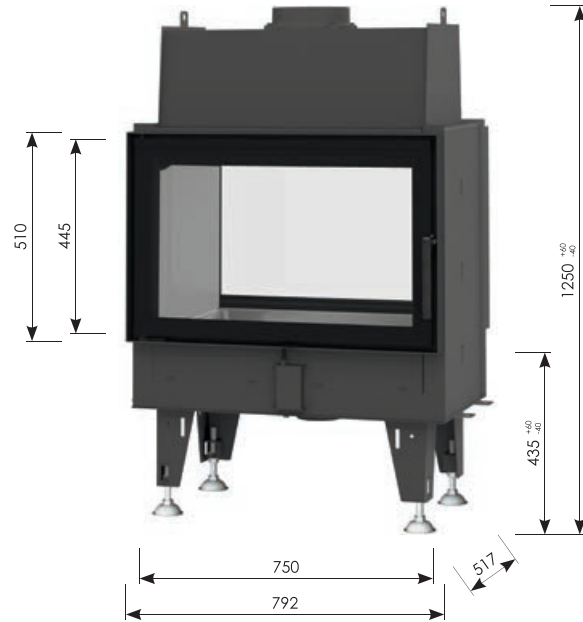

BEF TWIN 8

	5 - 11 kW
	80 %
	ø 200 mm
	50 cm
	192 kg





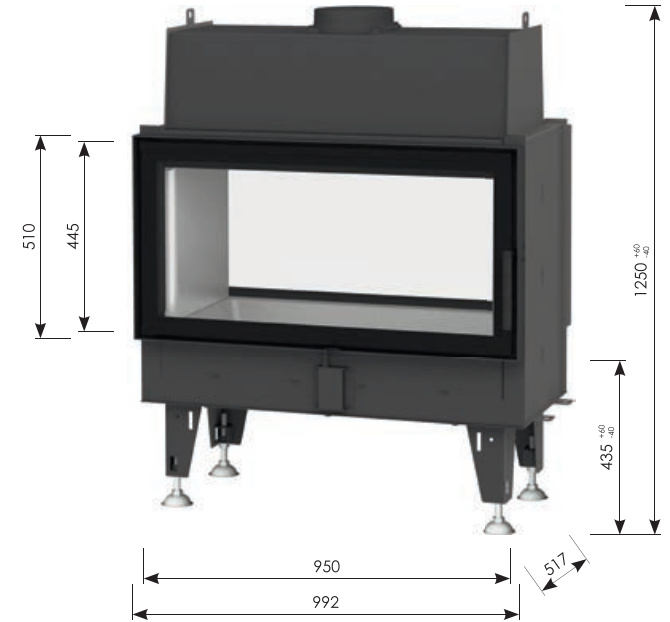

BEF TWIN 10

	8 - 14,5 kW
	83 %
	ø 200 mm
	66 cm
	225 kg







BEF TWIN V 8

	5 - 11 kW
	80 %
	ø 200 mm
	50 cm
	244 kg



BEF TWIN V 10

	8 - 14,5 kW
	83 %
	ø 200 mm
	66 cm
	294 kg

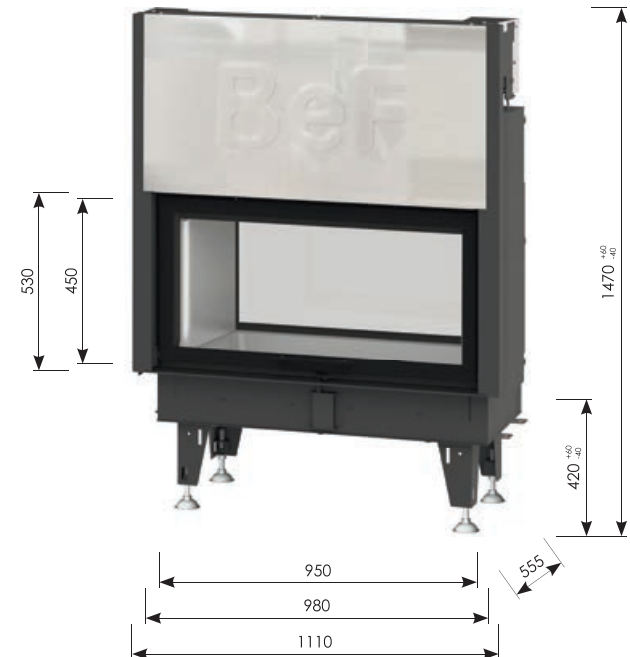

BEF TWIN 8 N

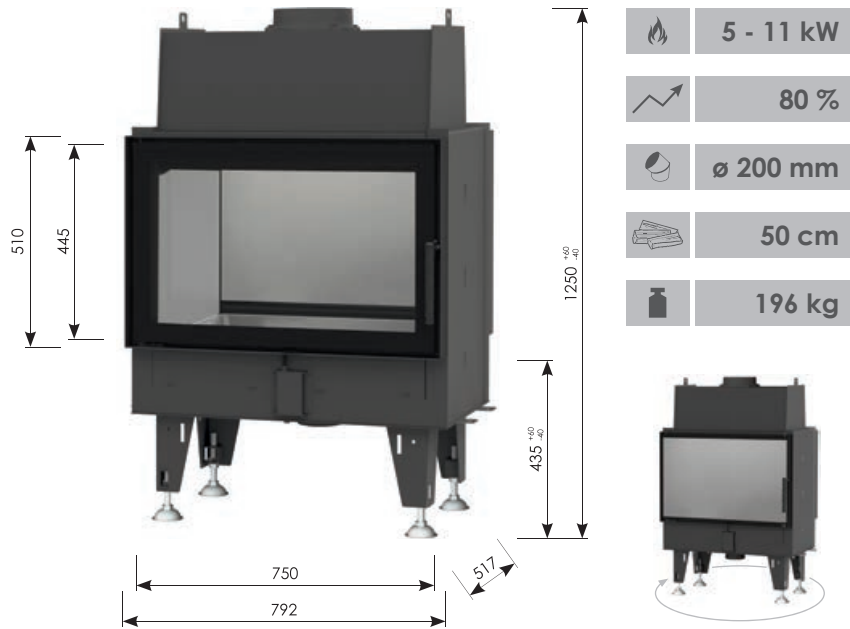

BEF TWIN 10 N

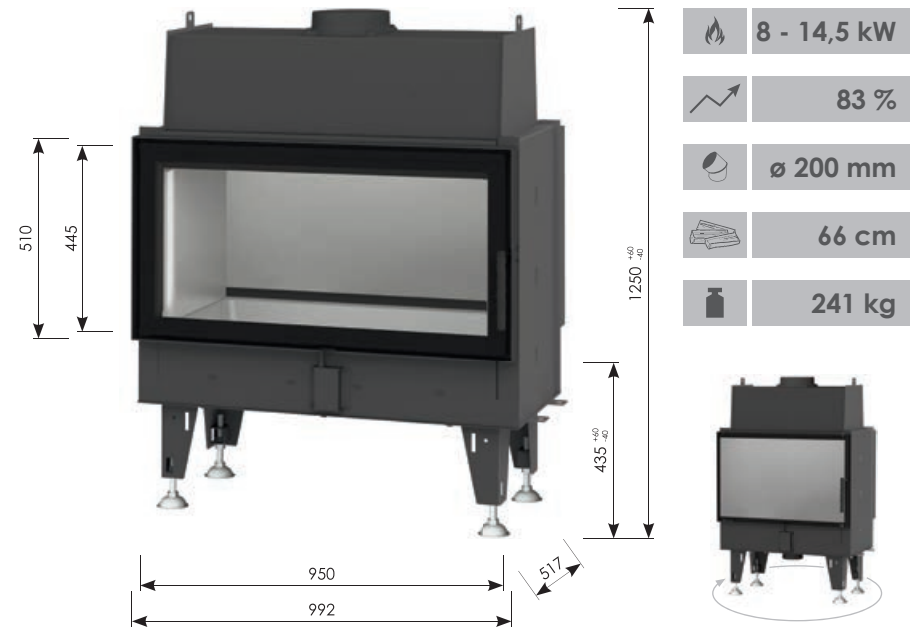

BEF TWIN V 8 N

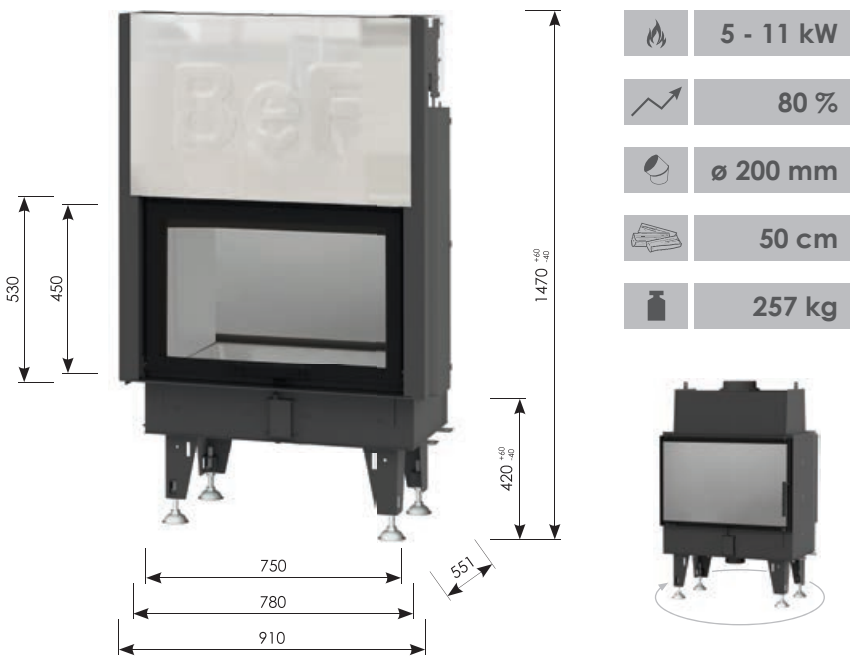

BEF TWIN V 10 N

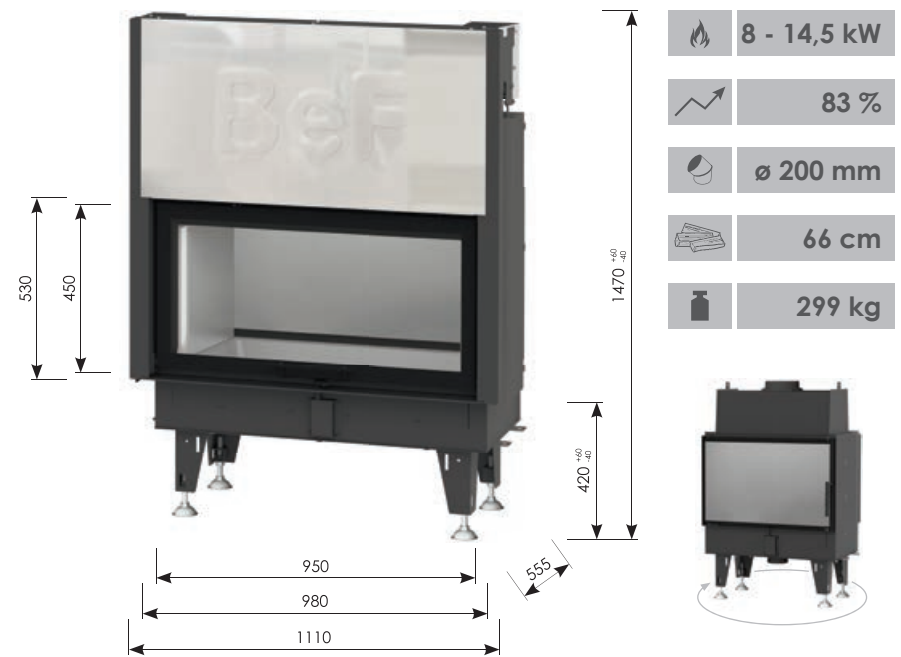



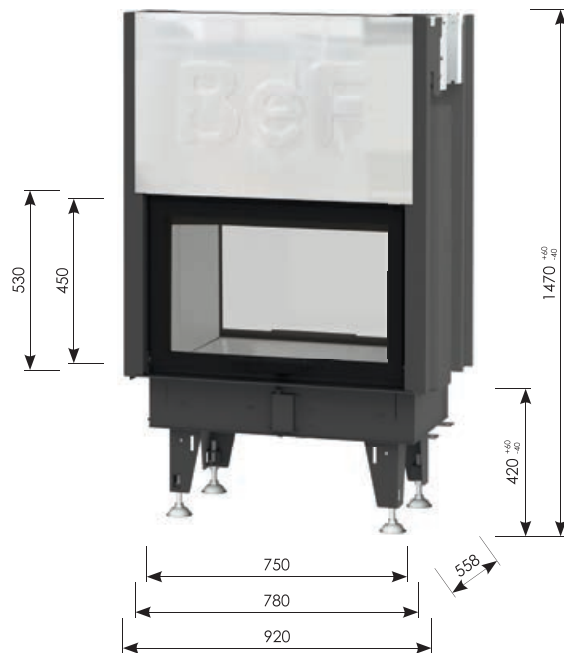

BEF TWIN V V 8

	5 - 11 kW
	80 %
	ø 200 mm
	50 cm
	299 kg







BEF TWIN V V 10

	8 - 14,5 kW
	83 %
	ø 200 mm
	66 cm
	353 kg





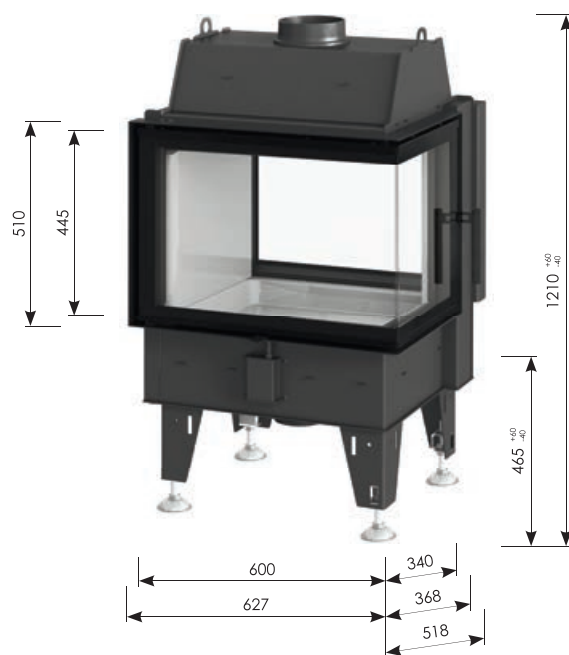

BEF TWIN 7 CP/CL

	4 - 7 kW
	82 %
	ø 150 mm
	40 cm
	147 kg





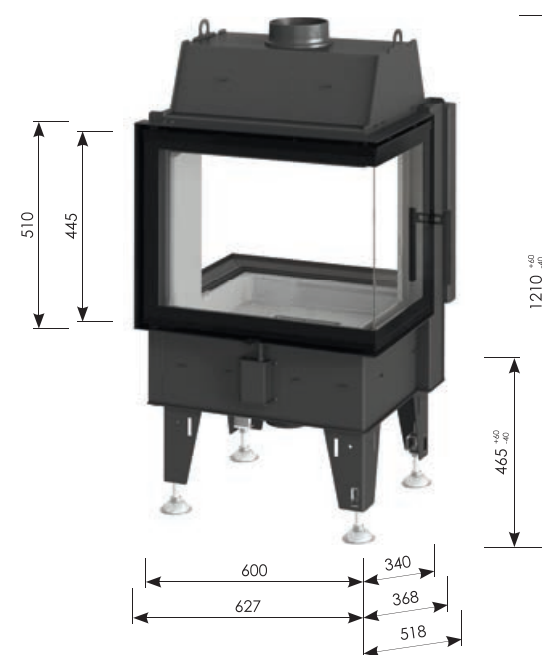

BEF TWIN 7 CP-CP/CL-CL

	4 - 7 kW
	82 %
	ø 150 mm
	40 cm
	137 kg







BEF TWIN V 7 CP/CL



	4 - 7 kW
	82 %
	Ø 150 mm
	40 cm
	193 kg







BEF TOWER 5 H

	5 - 8 kW
	82 %
	∅ 150 mm
	25 cm
	193 kg





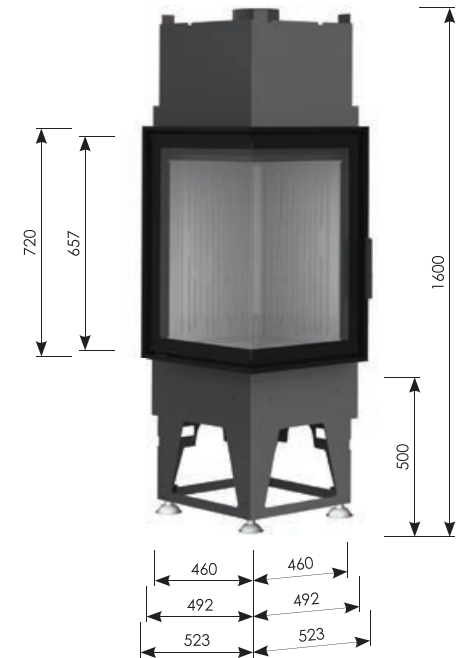

BEF TOWER 5 EH

	5 - 8 kW
	82 %
	∅ 150 mm
	25 cm
	184 kg





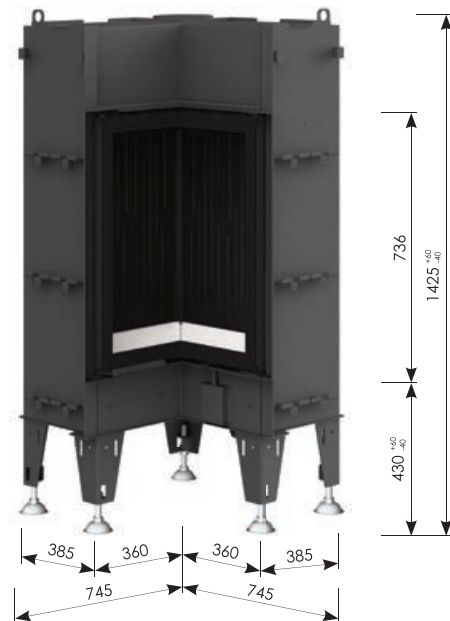

BEF TOWER 3 L

	5 - 8 kW
	82 %
	∅ 180 mm
	40 cm
	232 kg







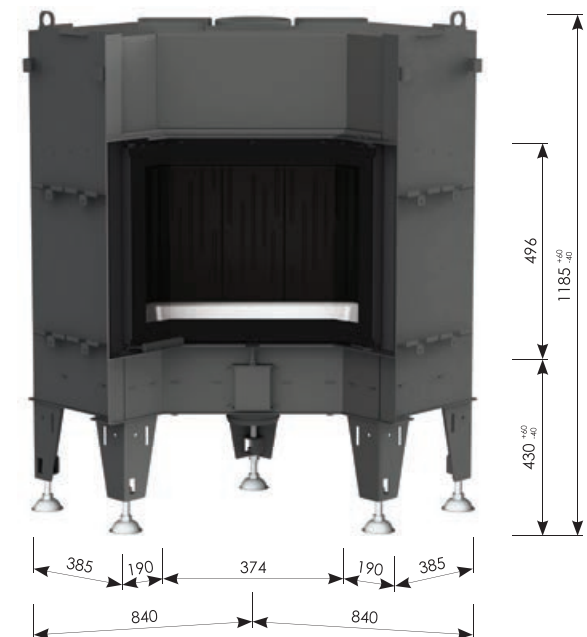

BEF TOWER 3 P

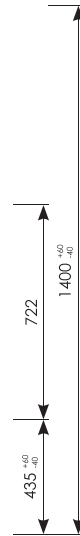
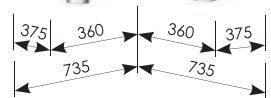
	5 - 8 kW
	82 %
	∅ 180 mm
	40 cm
	197 kg







BEF TOWER V 3 L



	5 - 8 kW
	82 %
	ø 180 mm
	40 cm
	237 kg





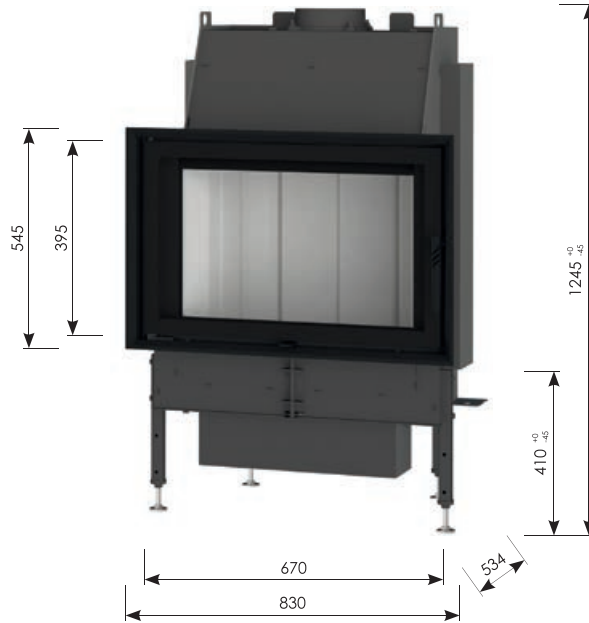

INTER 8

	6 - 13 kW
	80 %
	ø 180 mm
	50 cm
	171 kg



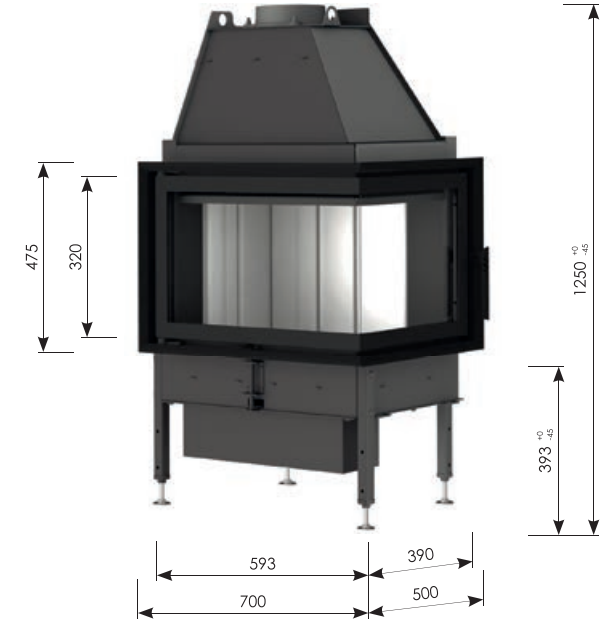

INTER 8 CP/CL

	6 - 13 kW
	80 %
	ø 180 mm
	50 cm
	201 kg







INTER V 8 CP/CL

	6 - 13 kW
	80 %
	ø 180 mm
	50 cm
	219 kg





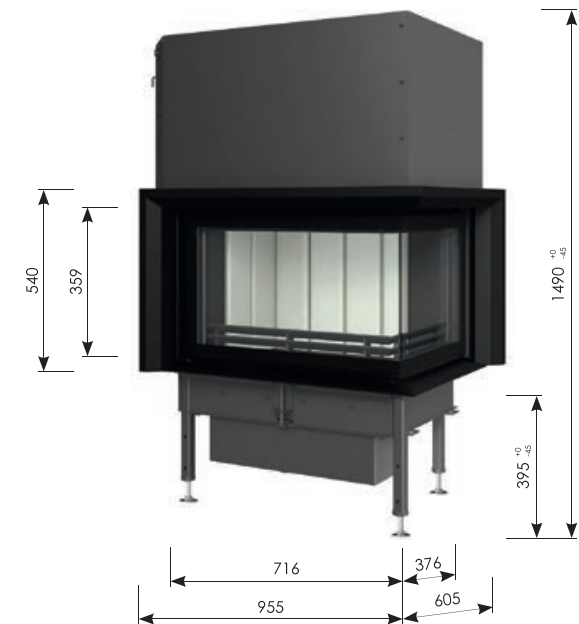

INTER V 9 CP/CL

	8 - 14,5 kW
	84 %
	ø 200 mm
	66 cm
	261 kg







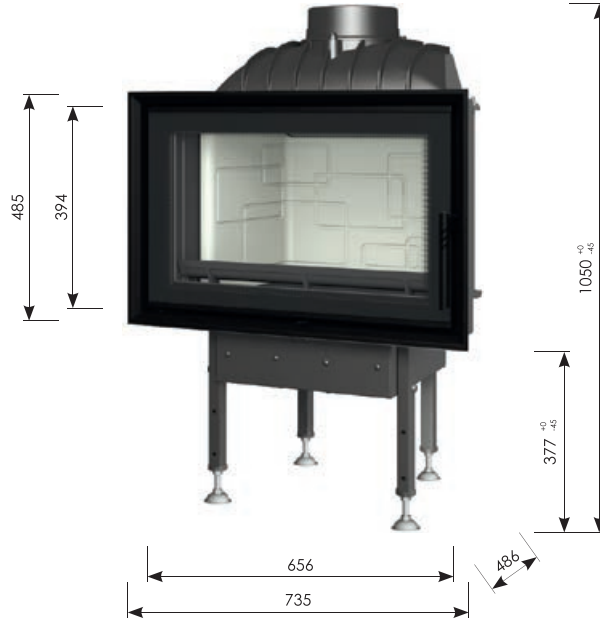

OPTIM 7

	5 - 8,5 kW
	79 %
	ø 200 mm
	40 cm
	130 kg



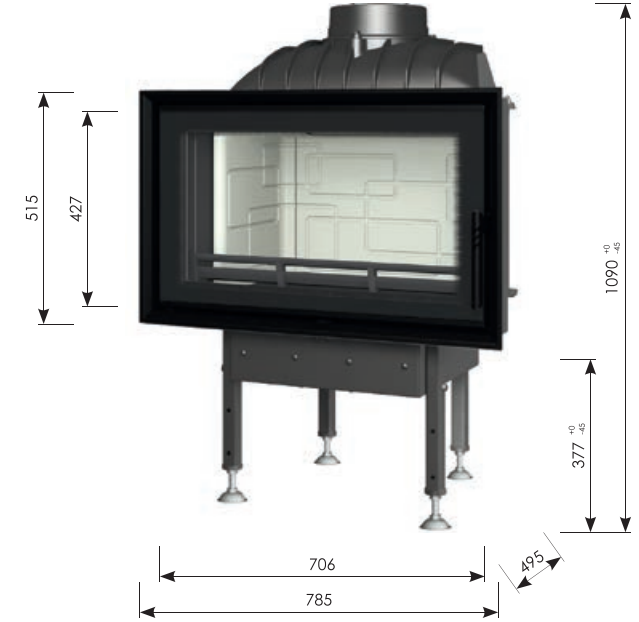

OPTIM 8

	6 - 10 kW
	78 %
	ø 200 mm
	50 cm
	161 kg





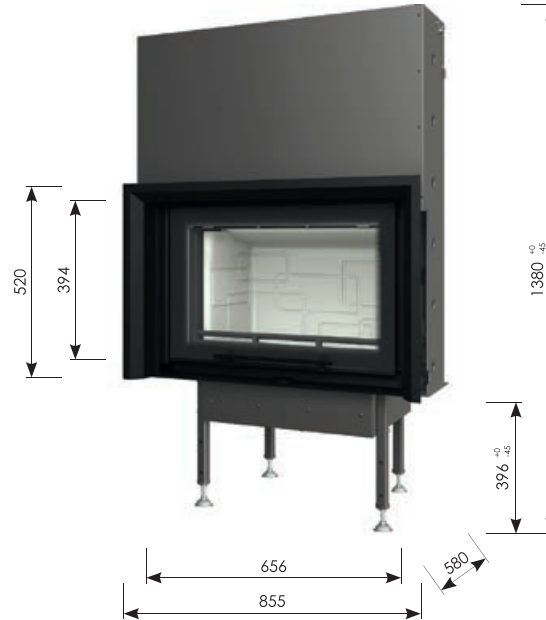

OPTIM V 7

	5 - 8,5 kW
	79 %
	ø 200 mm
	40 cm
	181 kg





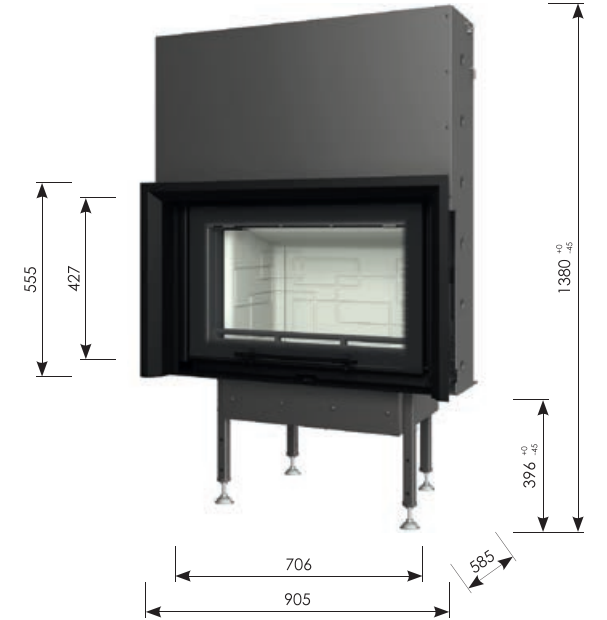

OPTIM V 8

	6 - 10 kW
	78 %
	ø 200 mm
	50 cm
	211 kg









BEF EFFI 6

	3 - 6 kW
	84 %
	ø 150 mm
	40 cm
	108 kg







BEF EFFI 7

	4 - 7 kW
	82 %
	ø 150 mm
	40 cm
	123 kg







BEF EFFI 8

	5 - 8 kW
	85 %
	ø 150 mm
	50 cm
	140 kg







BEF EFFI 6 S

	3 - 6 kW
	84 %
	ø 150 mm
	40 cm
	95 kg







BEF EFFI 7 S



	4 - 7 kW
	82 %
	ø 150 mm
	40 cm
	114 kg





BEF EFFI 8 S



	5 - 8 kW
	85 %
	ø 150 mm
	50 cm
	130 kg





BEF EFFI 6 CP/CL





	3 - 6 kW
	84 %
	ø 150 mm
	33 cm
	98 kg

BEF EFFI 7 CP/CL







	4 - 7 kW
	82 %
	ø 150 mm
	40 cm
	109 kg

BEF EFFI 8 CP/CL

	5 - 8 kW
	85 %
	ø 150 mm
	40 cm
	125 kg







BEF EFFI 6 S CP/CL

	3 - 6 kW
	84 %
	ø 150 mm
	33 cm
	77 kg







BEF EFFI 7 S CP/CL

	4 - 7 kW
	82 %
	ø 150 mm
	40 cm
	89 kg









BEF EFFI 8 S CP/CL

	5 - 8 kW
	85 %
	ø 150 mm
	40 cm
	101 kg









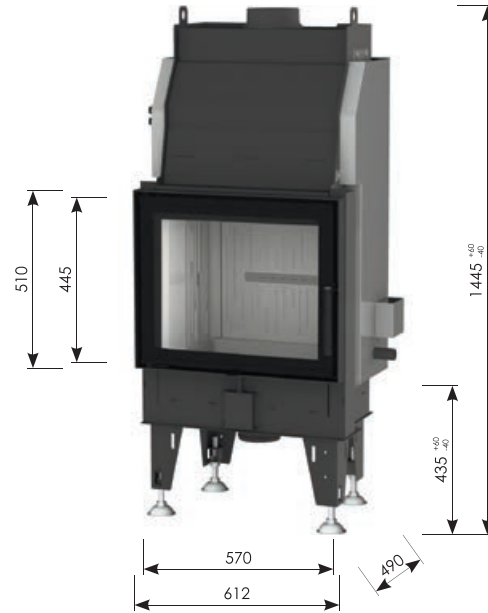

BEF AQUATIC WH 60

	7 - 11 kW
	4 - 8 kW
	86 %
	∅ 150 mm
	33 cm
	226 kg







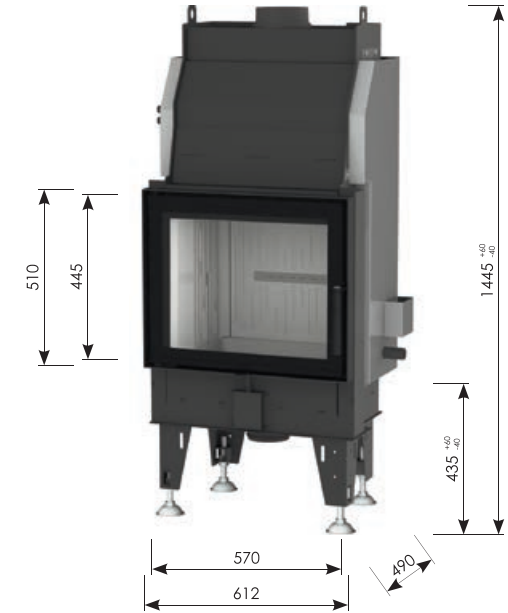

BEF AQUATIC WH 65

	9 - 14 kW
	4 - 10 kW
	88 %
	∅ 150 mm
	33 cm
	226 kg







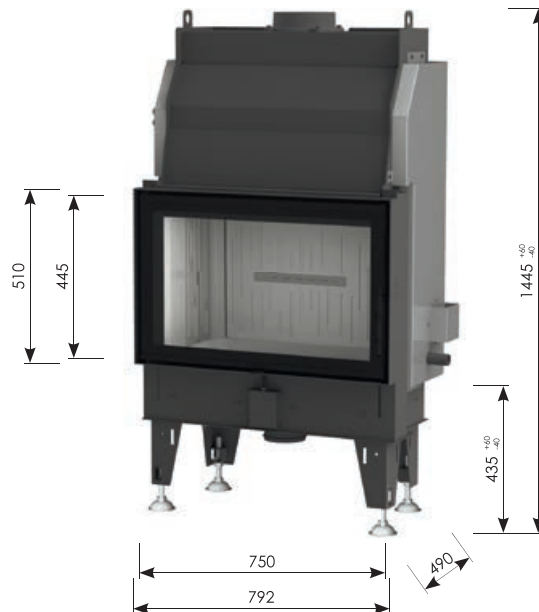

BEF AQUATIC WH 80

	9 - 18 kW
	7 - 12 kW
	84 %
	∅ 180 mm
	40 cm
	272 kg



BEF AQUATIC WH 85

	18 - 26 kW
	13 - 18 kW
	80 %
	∅ 180 mm
	40 cm
	272 kg

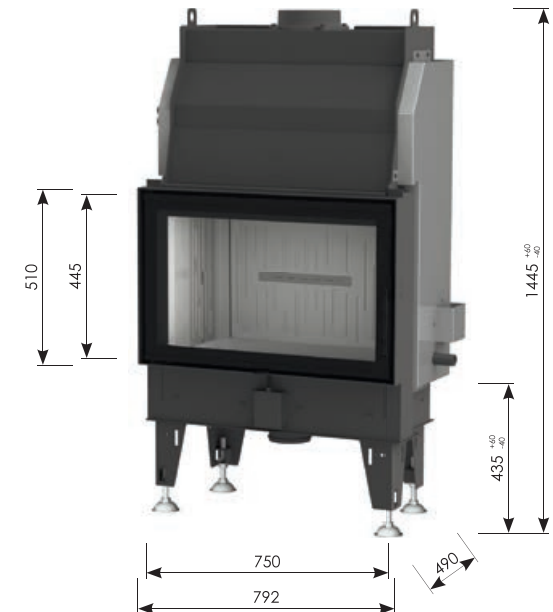

BEF AQUATIC WH 60 V

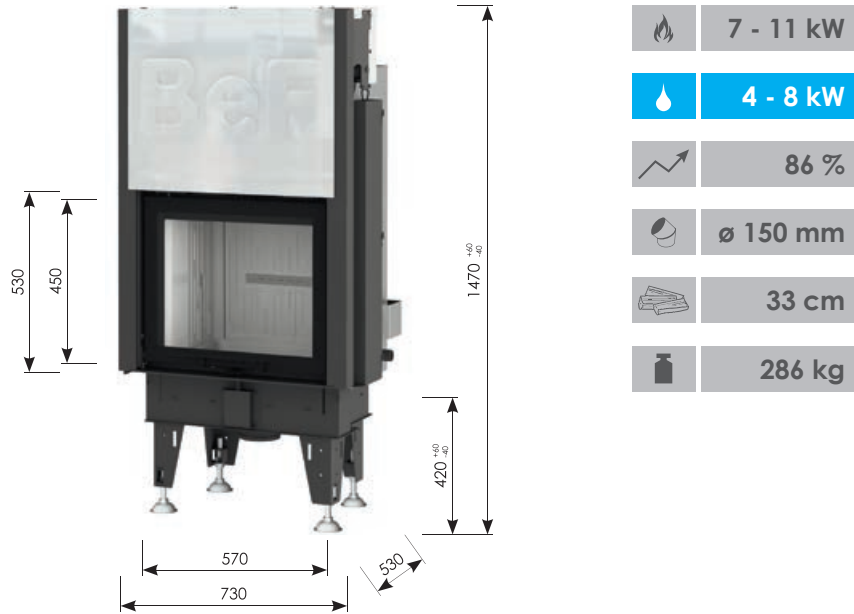

BEF AQUATIC WH 65 V

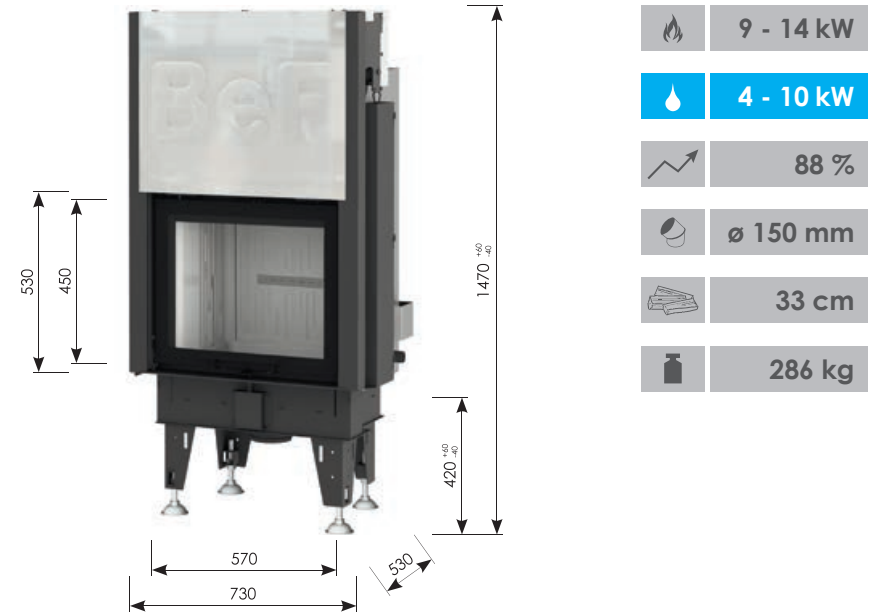



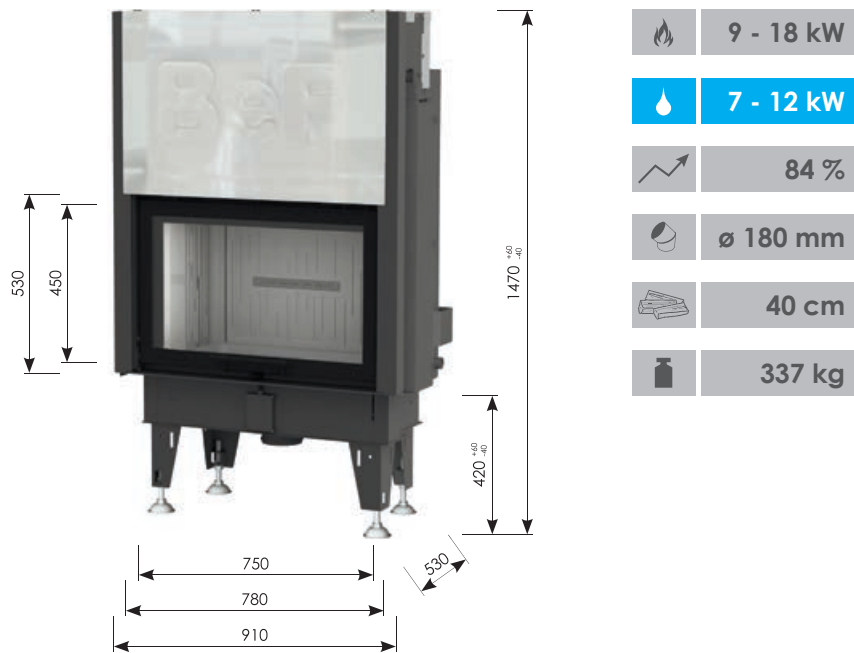

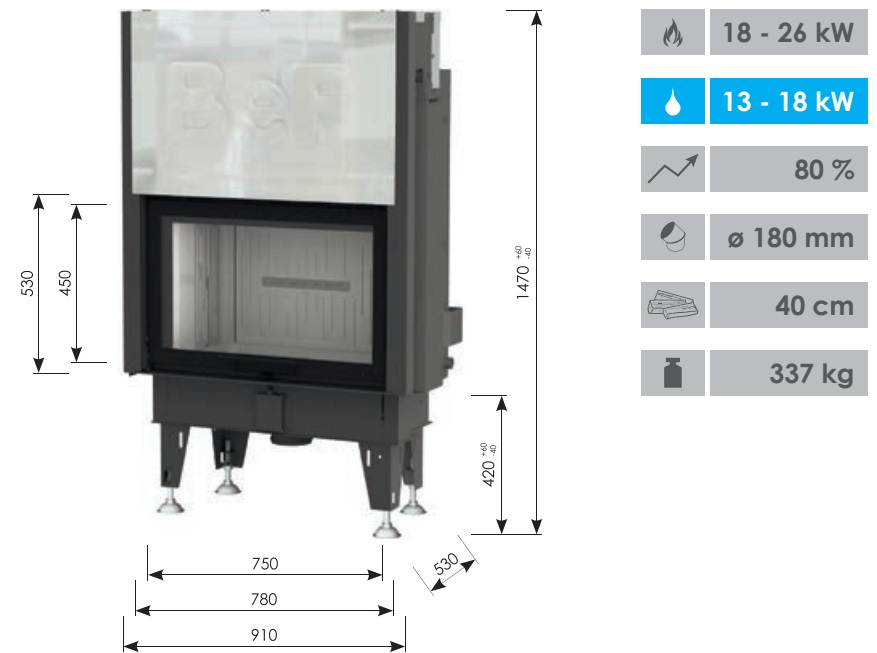

BEF AQUATIC WH 80 V



BEF AQUATIC WH 85 V







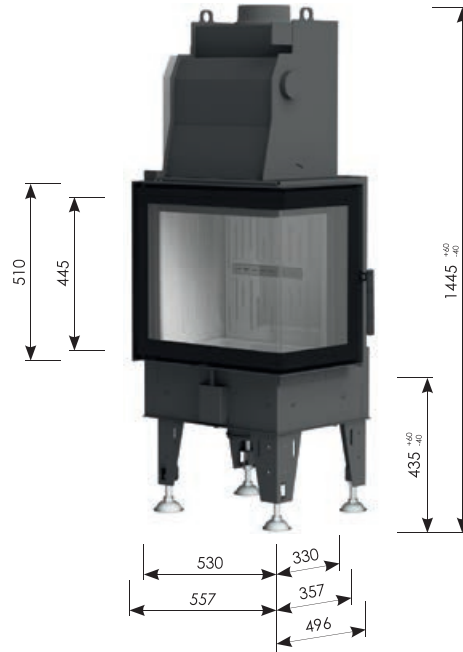

BEF AQUATIC WH 60 CP/CL

	7 - 11 kW
	4 - 8 kW
	86 %
	∅ 150 mm
	33 cm
	161 kg







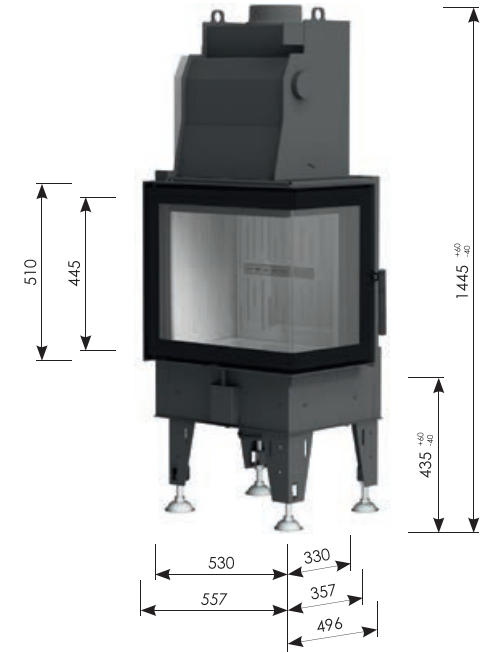

BEF AQUATIC WH 65 CP/CL

	9 - 14 kW
	4 - 10 kW
	88 %
	∅ 150 mm
	33 cm
	161 kg







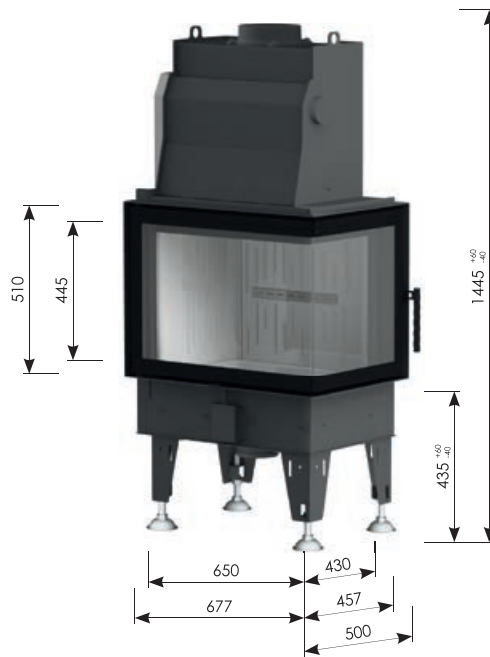

BEF AQUATIC WH 80 CP/CL

	9 - 18 kW
	7 - 12 kW
	84 %
	∅ 180 mm
	40 cm
	222 kg



BEF AQUATIC WH 85 CP/CL

	18 - 26 kW
	13 - 18 kW
	80 %
	∅ 180 mm
	40 cm
	222 kg

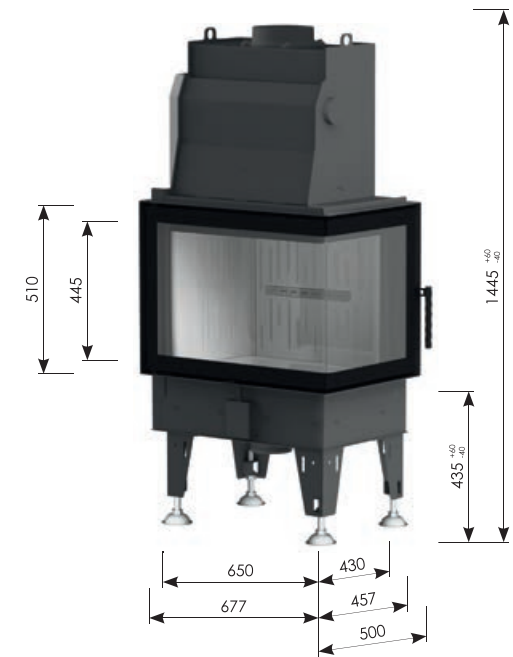

BEF AQUATIC WH 60 V CP/CL

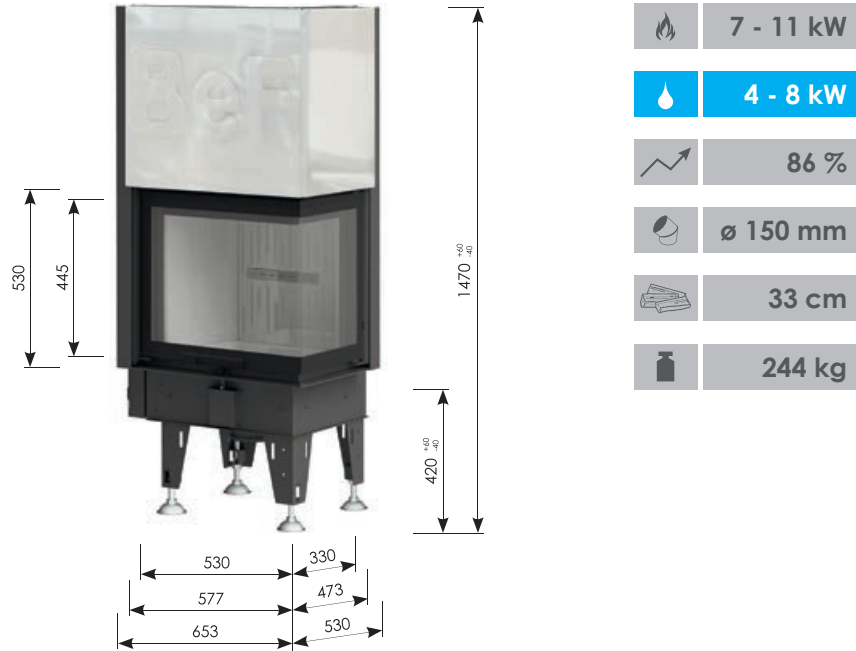

BEF AQUATIC WH 65 V CP/CL

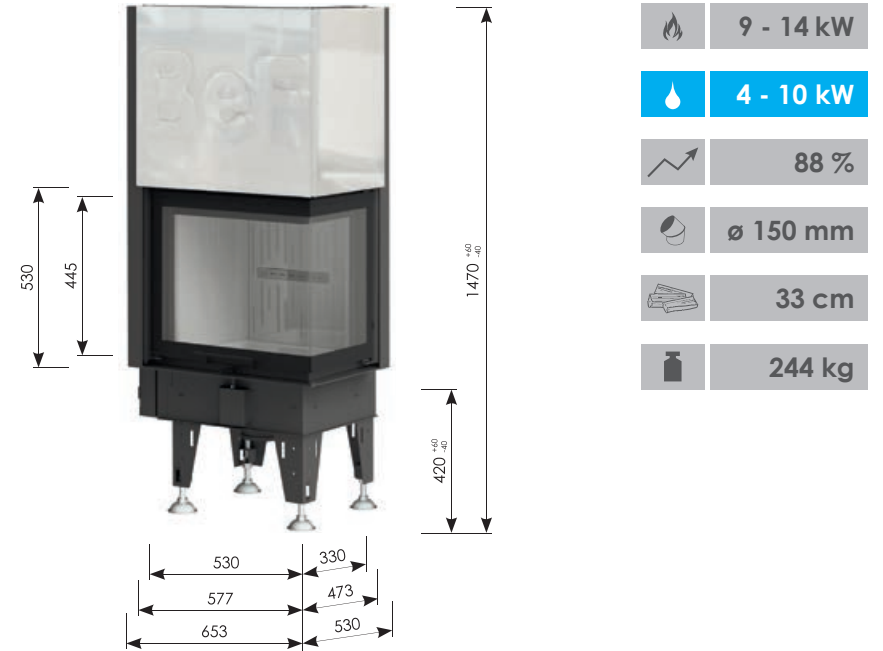

BEF AQUATIC WH 80 V CP/CL

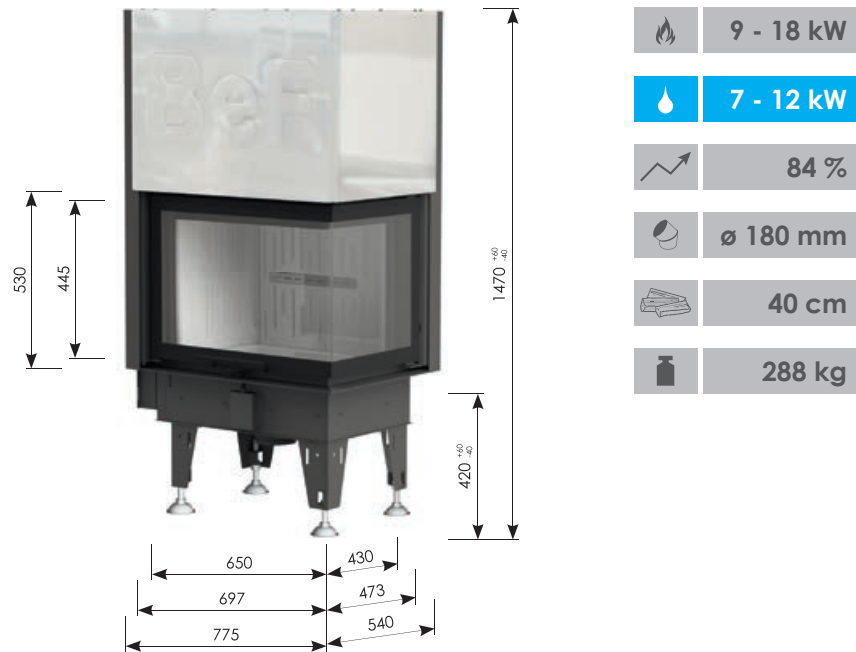



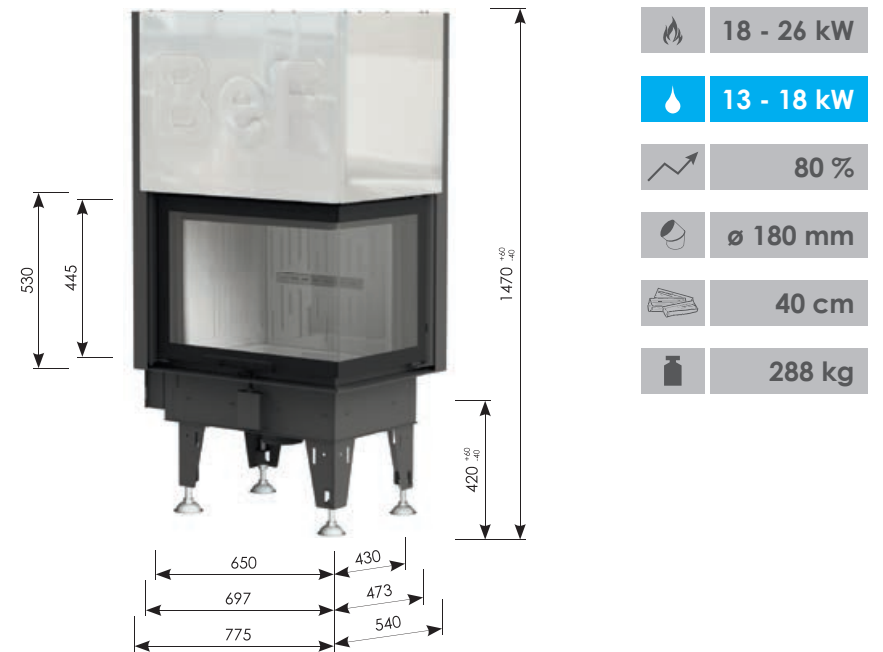



BEF AQUATIC WH 85 V CP/CL













AQUATIC WH 70

	7 - 14 kW
	4 - 10 kW
	87 %
	ø 180 mm
	40 cm
	193 kg







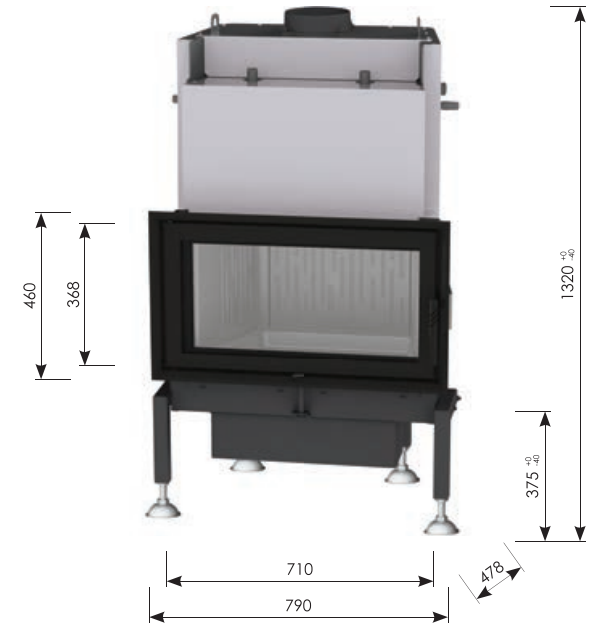

AQUATIC WH 75

	9 - 18 kW
	5 - 15 kW
	83 %
	ø 180 mm
	40 cm
	193 kg







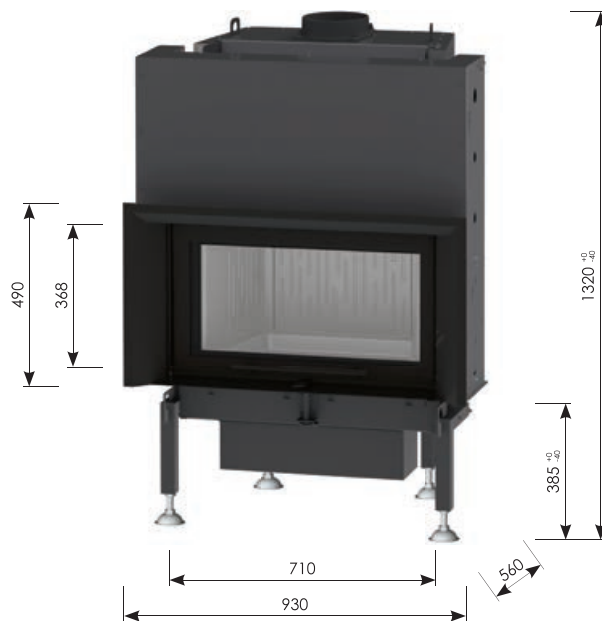

AQUATIC WH 70 V

	7 - 14 kW
	4 - 10 kW
	87 %
	ø 180 mm
	40 cm
	247 kg







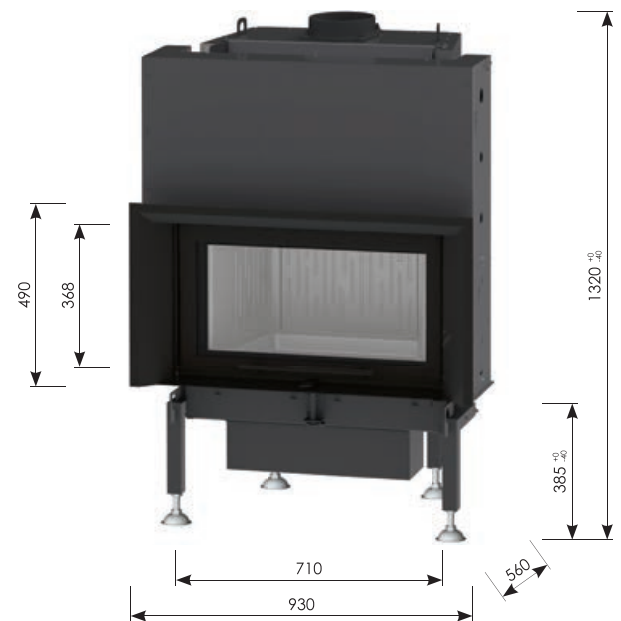

AQUATIC WH 75 V

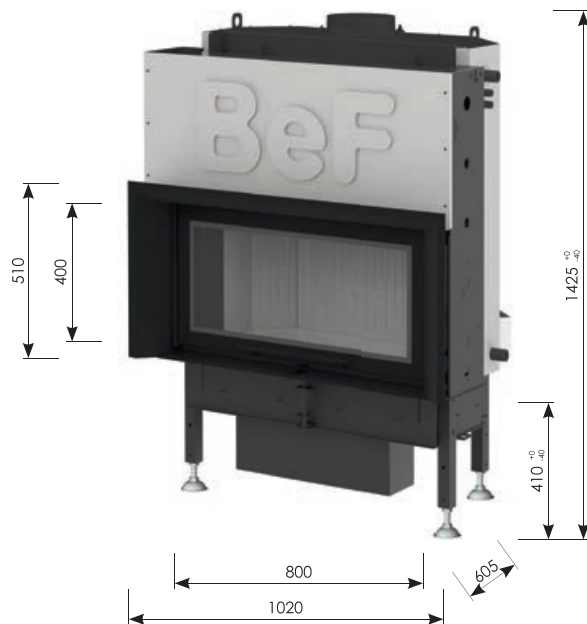
	9 - 18 kW
	5 - 15 kW
	83 %
	ø 180 mm
	40 cm
	247 kg









AQUATIC WH 100 V

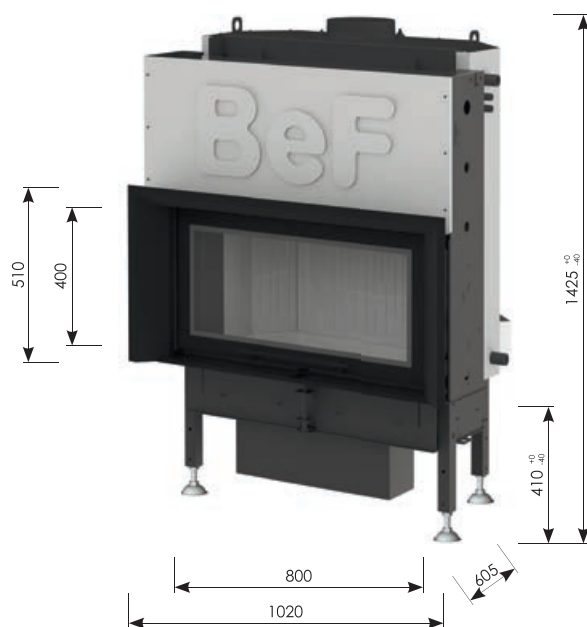

	10 - 20 kW
	9 - 14 kW
	86 %
	ø 200 mm
	50 cm
	343 kg







AQUATIC WH 105 V



	18 - 27 kW
	9 - 19 kW
	82 %
	ø 200 mm
	50 cm
	343 kg







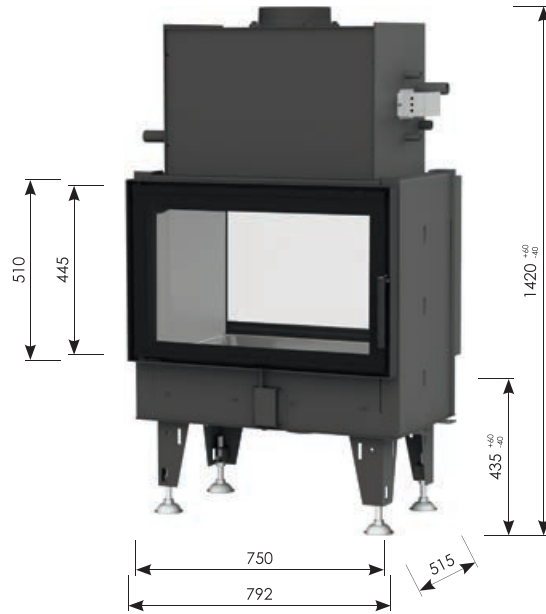

BEF TWIN 8 AQUATIC

	10 - 16 kW
	5 - 9 kW
	84 %
	ø 200 mm
	50 cm
	245 kg







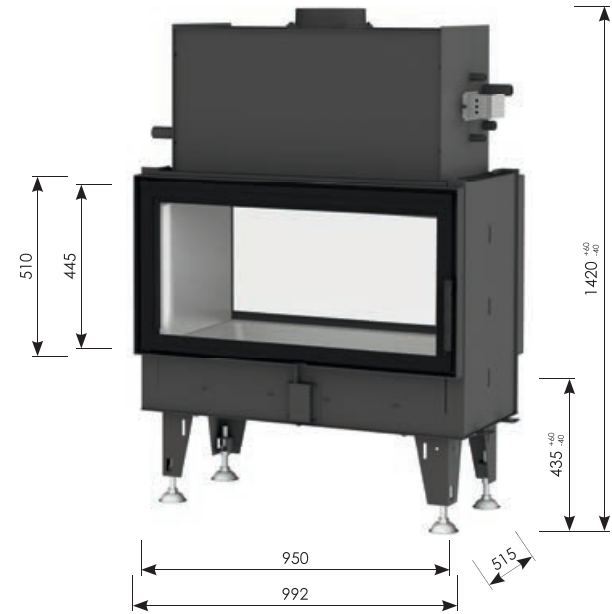

BEF TWIN 10 AQUATIC

	16 - 24 kW
	8 - 13 kW
	85 %
	ø 200 mm
	66 cm
	283 kg







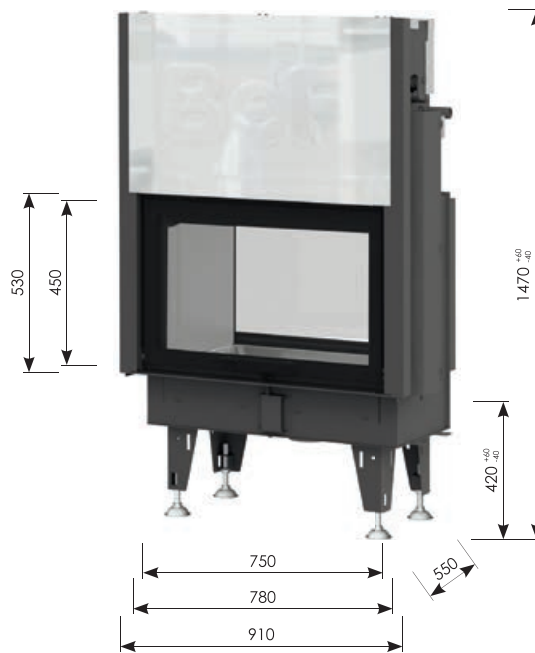

BEF TWIN V 8 AQUATIC

	10 - 16 kW
	5 - 9 kW
	84 %
	ø 200 mm
	50 cm
	302 kg



BEF TWIN V 10 AQUATIC

	16 - 24 kW
	8 - 13 kW
	85 %
	ø 200 mm
	66 cm
	342 kg

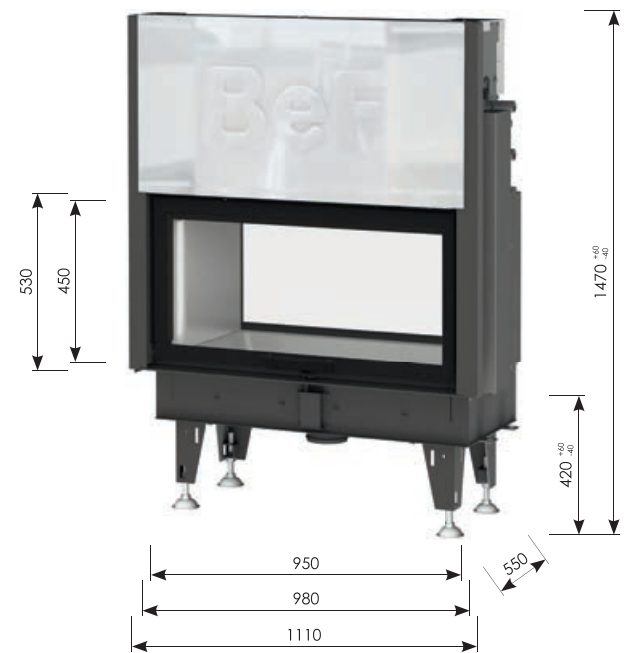

BEF TWIN V V 8 AQUATIC

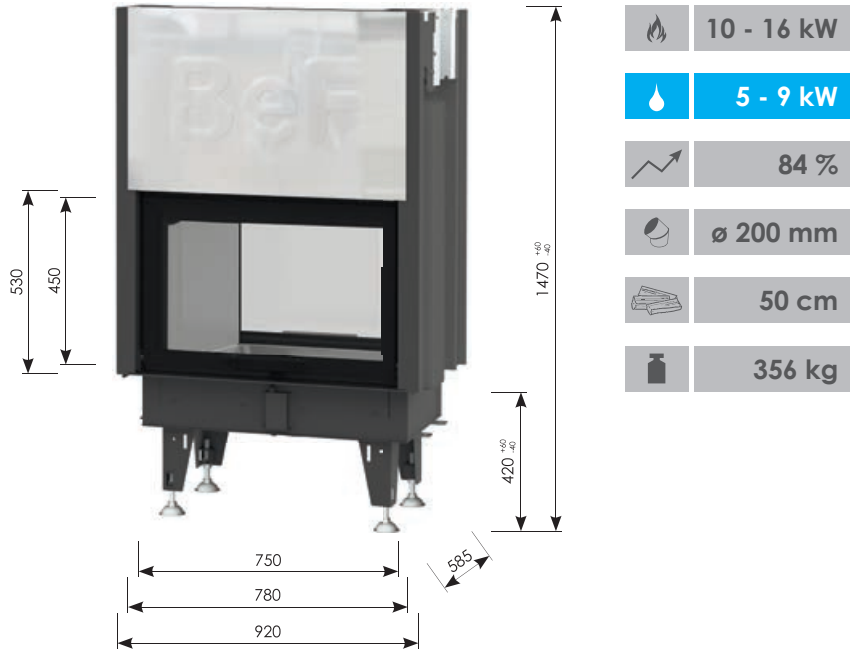

BEF TWIN V V 10 AQUATIC

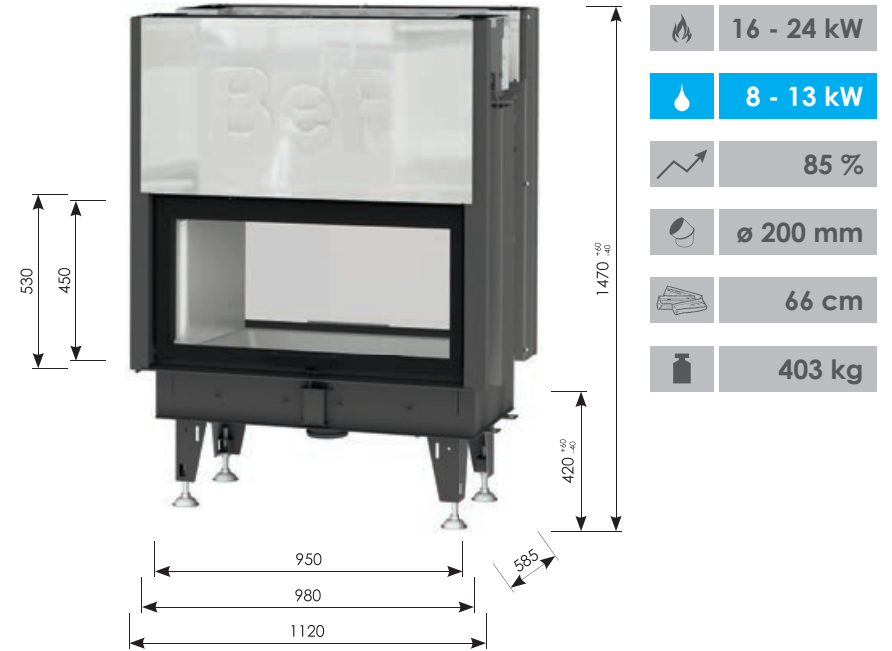



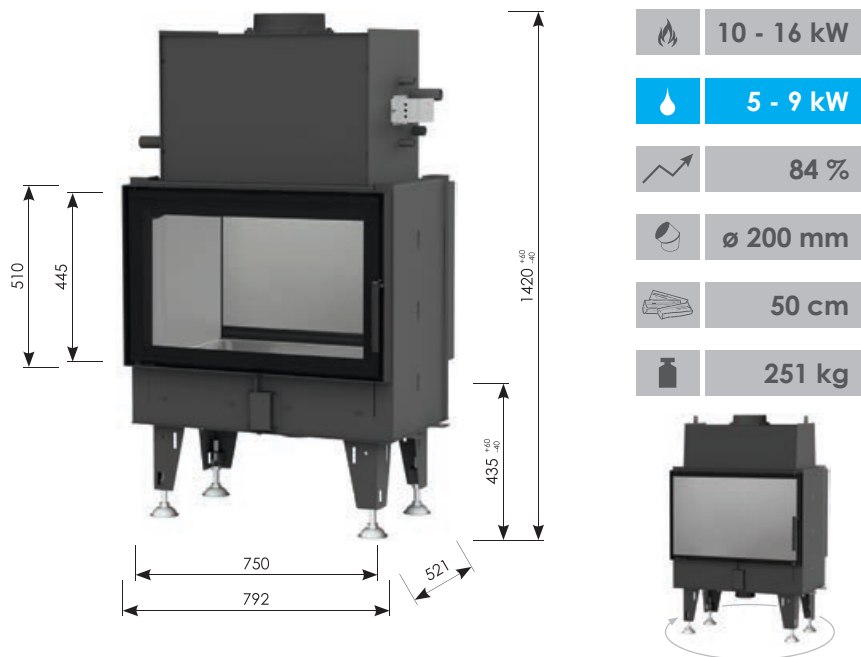

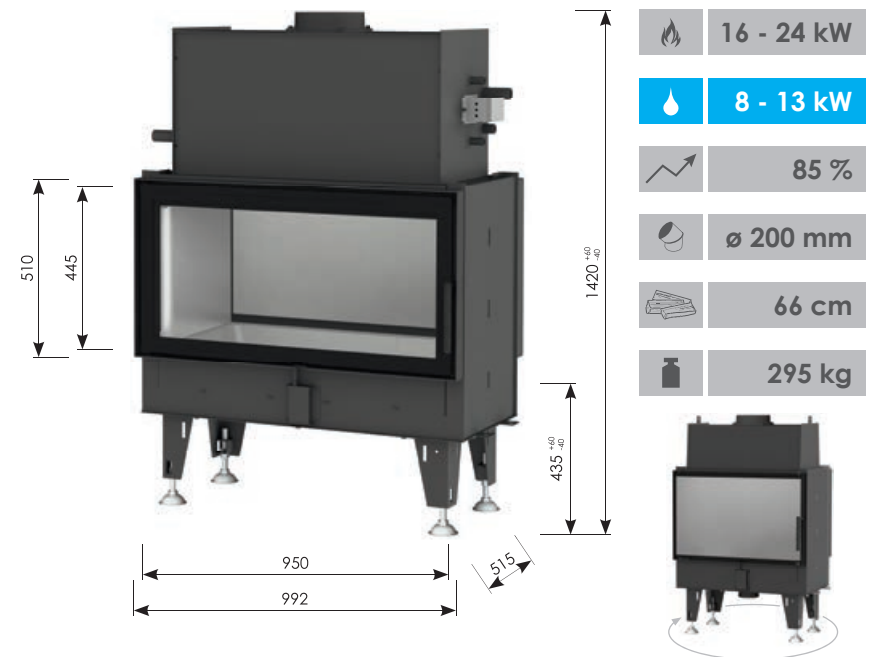

BEF TWIN 8 N AQUATIC



BEF TWIN 10 N AQUATIC









BEF TWIN V 8 N AQUATIC

-  10 - 16 kW
-  5 - 9 kW
-  84 %
-  ø 200 mm
-  50 cm
-  314 kg





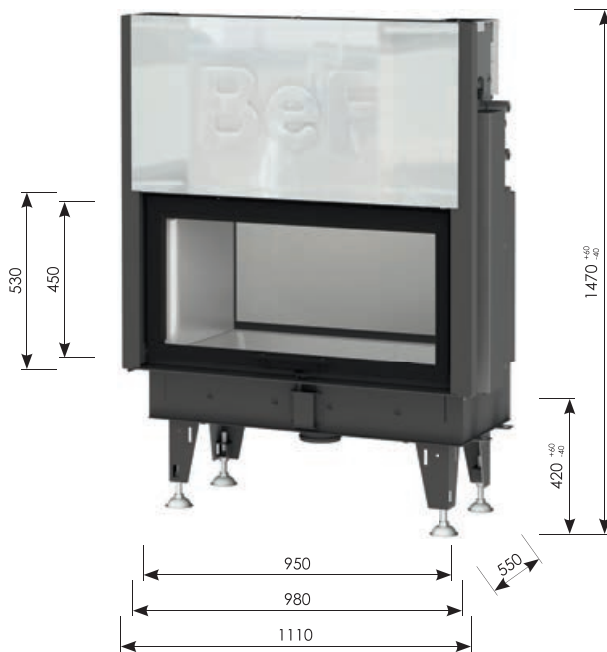

BEF TWIN V 10 N AQUATIC

-  16 - 24 kW
-  8 - 13 kW
-  85 %
-  ø 200 mm
-  66 cm
-  351 kg









BEF ARIES 3

	3 - 6 kW
	83 %
	Ø 150 mm
	20 cm
	155 kg





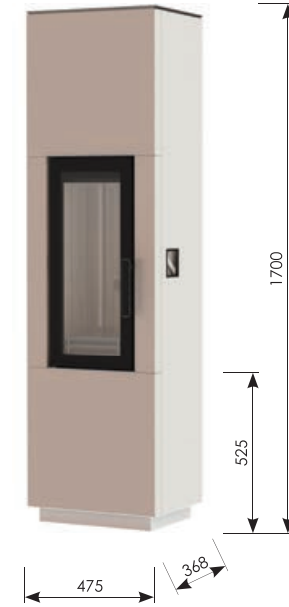

BEF ARIES 7

	3 - 6 kW
	83 %
	Ø 150 mm
	20 cm
	166 kg





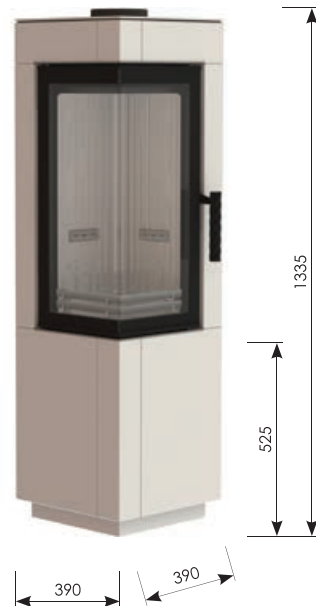

BEF ARIES 3 E

	3 - 6 kW
	83 %
	Ø 150 mm
	20 cm
	133 kg







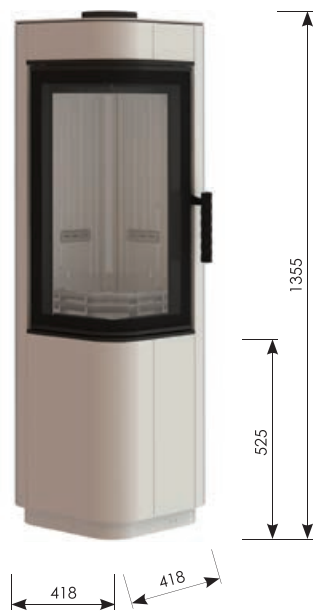

BEF ARIES 7 E

	3 - 6 kW
	83 %
	Ø 150 mm
	20 cm
	157 kg









BEF ARIES 3 ER

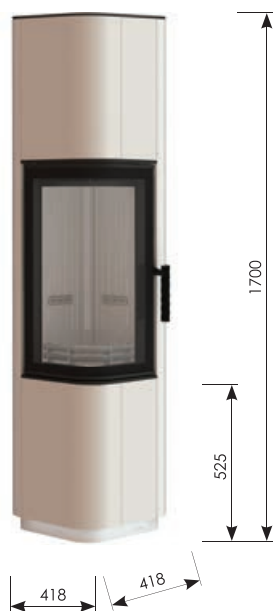

	3 - 6 kW
	83 %
	ø 150 mm
	20 cm
	143 kg



BEF ARIES 7 ER



	3 - 6 kW
	83 %
	ø 150 mm
	20 cm
	173 kg







BEF VIRGO 7

	5 - 8 kW
	82 %
	ø 150 mm
	25 cm
	236 kg



BEF VIRGO 7 E

	5 - 8 kW
	82 %
	ø 150 mm
	25 cm
	224 kg





These data are informative, the manufacturer reserves the right to change.

www.befhome.com

Kotvrdovice 277, 679 07 Kotvrdovice • tel.: +420 516 428 240 • e-mail: info@bef.cz • fax: +420 516 428 244

Turá Lúka, 907 03 Myjava • tel.: +421 346 216 790 • e-mail: info@bef.sk

Bąków ul. Główna 4a, 43-246 Strumień • tel.: +48 338 561 009 • e-mail: info@befpolska.com • fax: +48 338 571 325

1 Place de l'Homme de Fer, 67 000 Strasbourg • tél.: 00 33 (0)6 72 38 31 13 • e-mail: info@foyers-bef.fr



04121600